



25
(2nd edition)

ULTIMHEAT[®]



Flexible heating elements in silicone

The Gigathermic[®] professional range

The professional solution: an extended, rational, and consistent range of products
Technical catalogue for R&D department
Edition 08/10/2019







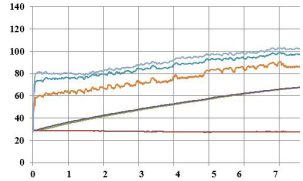
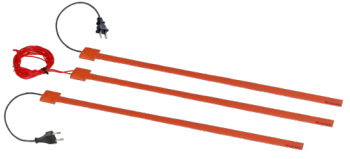

Contact us

Web: www.ultimheat.com



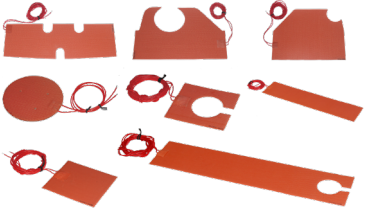





Summary

Because of permanent improvement of our products, drawings, descriptions, features used on these data sheets are for guidance only and can be modified without prior advice

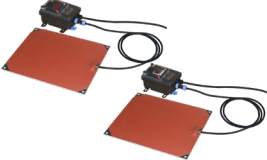
Section 1	Summary		P1-P4
Section 2		Historical introduction	P1-P4
		Technical introduction	P5-P38
Section 3	List of references		P1
Heating ribbons for heat tracing			P1-P8
Section 4		9AS Heating flat ribbons in silicone, width 15mm, maximum length 10m, with or without adhesive. No built-in thermostats. Can be fitted with temperature sensor for remote temperature control and with PTC self-regulated wires.	P3-P5
		9AD Heating flat ribbons, width 35mm, maximum length 10 meters, with over-moulded fixed setting ambient thermostat, with or without adhesive, for antifreeze or heating applications. Power supply by wires or by cord.	P6-P8
Heating belts.			P1-P12
Section 5		9AF Heating belts for metal drums, with surface mounted bimetal thermostat. Made in 2.5mm and 3.2mm thickness, width 100 mm.	P3-P4
		9AB Heating belts for metal drums, with surface mounted bulb and capillary thermostat. Made in 2.5mm and 3.2mm thickness, width 100, 200, 300 and 400mm.	P5-P6
		9AC 9AQ Heating belts for metal drums, with remote electronic control. Made in 2.5mm and 3.2mm thickness, width 100, 200, 300 and 400mm.	P7-P12
Flexible silicone rubber heating pads			P1-P10
Section 6		9AR Flexible silicone heating pads, rectangular or special designs, with or without adhesive. Can be equipped with temperature sensor for remote temperature control, or/ and surface mounted miniature temperature limiters with fixed setting. They can be made in 1.6, 2.5mm and 3.2mm thickness.	P3-P4
		9AE Flexible silicone heating pads with adjustable thermostat, with or without adhesive. Made in 2.5mm and 3.2mm thickness.	P5-P6

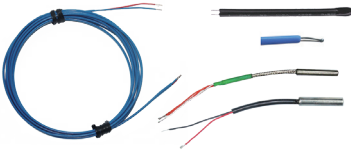

Summary

Section 6		9AG 9AJ	Flexible silicone heating pads with remote electronic control, with or without adhesive. Made in 2.5mm and 3.2mm thickness.	P7-P10
Non flexible heaters, vulcanized on aluminium board				P1-P8
Section 7		9AK	Non flexible silicone heaters vulcanized on aluminium board, surface mounted adjustable thermostat.	P3-P4
		9AL 9AM	Non flexible silicone heaters vulcanized on aluminium board, electronic remote temperature control.	P5-P8
Temperature controls.				P1-P22
Section 8		UJA, 4A, 4903, 4R05, 4T	Fixed setting temperature limiters.	P3-P4
		IB, 8G, 8C	Adjustable mechanical thermostats. Bimetal or bulb and capillary types.	P5-P7
		TPR, TS0, TSR, TNR	Temperature sensors for incorporation inside flexible silicone heaters: thermocouples, Pt100, NTC.	P8-P11
		2PE2, 2DNA, 273, 244	Electronic temperature controllers. Din Rail mounting or panel mounting. On-Off or PID action.	P12-P17
		Y22	Waterproof antifreeze control box with fixed temperature at 4°C. Switch on the 15mm heating ribbons type 9AS according to the ambient temperature.	P18
		Y8WH Y8WJ	Electronic temperature control boxes for remote control. On-Off or PID action.	P19-P22

Because of permanent improvement of our products, drawings, descriptions, features used on these data sheets are for guidance only and can be modified without prior advice









Summary

Mounting accessories for flexible silicone heaters

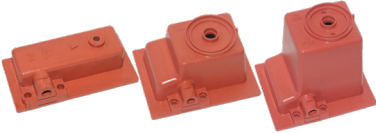
P1-P14

Because of permanent improvement of our products, drawings, descriptions, features used on these data sheets are for guidance only and can be modified without prior advice

Section 9		9BFL	Silicone boots for mounting fixed setting limiters or thermostats on flexible silicone heaters. Assembly by bonding or vulcanization.	P3
		9BFS	Silicone boots mounting of temperature sensors and thermostats bulbs on flexible silicone heaters surface. Assembly by bonding or vulcanization.	P4
		9BFF	Silicone enclosures for surface mounting of adjustable thermostats. Assembly by bonding, vulcanization and/or riveting.	P5
		9BFH	Silicone boots for cable outputs on flexible silicone heaters, Assembly by bonding or vulcanization.	P6
		9BFP	Silicone boots for cable outputs with temperature limiters on flexible silicone heaters. Assembly by bonding or vulcanization.	P7
		9BFM	Silicone boots for cable outputs with temperature sensors on flexible silicone heaters. Assembly by bonding or vulcanization.	P8
		9BFV	Silicone boots for cables and wires output with temperature sensor and temperature limiter on flexible flat silicone heaters. Assembly by bonding or vulcanization.	P9





Contact us

Web: www.ultimheat.com

Cat25-2-1-3

Summary

Section 9 Various accessories		9V4	Heating base for metal drum	P13
		6YTMC2	Various accessories - High temperature silicone bonding and filling agent.	P14
		9A66GT1	Various accessories - Grounding cord.	P14

Because of permanent improvement of our products, drawings, descriptions, features used on these data sheets are for guidance only and can be modified without prior advice



Historical introduction

Because of permanent improvement of our products, drawings, descriptions, features used on these data sheets are for guidance only and can be modified without prior advice

Update 2019/10/29



Contact us

Web: www.ultimheat.com

Cat25-2-2-1



History of flexible heaters in silicone rubber sheets

2019/08/29

The appearance, in the years 1960/70, of this type of heaters, now universally used, is due to the conjunction of the development of several techniques: that of the vulcanization of elastomers on textile fabrics or on electrical conductors, that of manufacturing glass fabrics, that of the manufacture of silicone, that of the coating of silicone on glass fabrics.

The first tests of vulcanized heating wires in an elastomer, in this case rubber, date back to the first years of the 19th century, and the tariff published in the official journal of 5 August 1912 states «electric heating mats made of rubberized fabric used as insulation to an electrical heating wire »

The manufacture of fiberglass fabric dates back to 1893, when two dresses were made, the first for an actress, the second, which must still be in a museum in Toledo, for a Spanish princess. These were mere curiosities: the fabric was heavy, of a difficult cut; it irritated the skin and did not support many folds; the dress could only be worn with a thick silk undergarment. At that time, the glass fibers were indeed obtained by a process which did not differ much from that which was used to obtain the glass silk in laboratories: a glass rod was stretched from its ends, first by hand, then by winding on a drum animated with a rapid rotation movement. The diameter of these fibers, quite irregular, was at least 25 microns. (1938 Le Génie Civil)

The industrial manufacture of fiberglass was born from the necessity for the Germans, from the beginning of the First World War, to find, in order to manufacture various insulators, a substitute for asbestos, a product which they had previously totally imported . As early as 1915, the Gossler factory in Dusseldorf manufactured a glass silk whose fineness and flexibility were rapidly improved and which not only was able to replace asbestos, but could also be used to manufacture thin sheets with entangled fibers, used to filter gases and rid them of the finest dust. First of all, the manufacturing process did not differ essentially from the intermittent process of drawing rods by hand and drum; but in 1931, after many attempts, it was possible to make the manufacture entirely mechanical and continuous, by using a jet of steam.

In 1937, two factories, one in Germany and the other in the United States, could commonly manufacture glass fibers of less than 5 microns. At that time, apart from furnishing fabrics, glass fiber silk threads were used only to make porous, electrical, acoustic or thermal insulators, filters, gaskets, and plastic cements.

The description of the manufacturing processes, whose development took more than 3 years was described in July 1938 in an article by MJH Plummer of Owens-Illinois Glass Co, Newark, Ohio, (published in Industrial and Engineering Chemistry), then in August of the same year in an article by M. Th. R. Olive, (published in Chemical and Metallurgical Engineering) (1938 Le Génie Civil)

This new insulating textile material that could be woven, named “Silionne”, revolutionized the manufacture of flexible heating elements. Invented and first produced in the USA by Owens Corning it appeared in France in 1938. But it was only around 1952-1954 that this fiber was produced industrially under license in France. This flexible fiber, (also called glass silk because the diameter of the filaments was similar to that of silk), is formed from molten glass at 1300°C. It is then extruded and stretched into filaments (strands) with an average diameter between 5 to 9 microns combined into single threads of 100 to 600 filaments. These single wires are then grouped and “twisted” to form cords that make up the core of the flexible heating elements, or the wrapping of the electrical wires.

Among the first applications we can name its use, in the strengthening of plastics, when in 1941 began the realization of a aircraft made of plastic resin impregnated fiberglass. The fuselage was built in the first place and was found to be 50 percent stronger in static resistance tests than a conventional metal fuselage. One aircraft of this construction completed 500 flying hours, mostly in the Arctic, during the winter season. The material consisted of 50 percent fiberglass and 45 percent resin. The fiberglass fabric was impregnated with Plasko resin “911” (l'Aviation française 16 Juillet 1947)

Silionne was an excellent electrical insulator, and was non-flammable and resistant to high temperatures. It was also braided and woven and as soon as it appeared, it was used for the production of sheets and fabrics. As early as 1948, glass fabrics were used by the French company “Tentation” in the manufacture of electric blankets, just as some American manufacturers were already doing. It also rapidly replaced many asbestos applications, including the conductor core around which the conductor wires of the heating cords were spiraled.

Developed in 1940 with rubber insulation, flexible fabrics were quickly put to use for de-icing aircraft wings.



Historical introduction

At the same time appeared the silicone rubber.

Invented by Dow Corning in the US shortly before the Second World War, and made public in 1944, silicone rubber was initially reserved for military applications. Rhône Poulenc began experimentally producing silicone (Rhodorsil) in Lyon in 1948, and then opened its Saint Fons factory near Lyon in 1954. This elastomer was first used to impregnate braided fiberglass sleeving, allowing small electric motors to operate at a higher temperature. This glass silk withstood heat very well. Its silicone impregnation gave it good water ingress protection and resistance to many chemical agents. (1954 Meci, Ultimheat catalog)

In 1949, Dow Corning USA engineer Earl.L Warrick developed a silicone elastomer with a small percentage of iron oxide (less than 2%) to improve its heat stability. This low percentage stained the silicone in orange-brown. (US Patent 2,541,137). Firstly in 1952 in the USA, and secondly in 1953 in France, Dow Corning patented a calendaring technique to deposit a layer of partially vulcanized rubber or silicone on a textile support. This technique made it possible to make sheets and ribbons whose adhesion on a support or on a heating wire could be realized in a simple way by a subsequent heating. This paved the way for flexible heating elements made of silicone rubber and other heat vulcanizable resins. (French patent 1,090,190)

In 1960 the Compagnie Française Thomson-Houston, filed in France the American patent of William Joseph Bobear (US Patent General Electric 3,053,687). This patent improved the coating of fiberglass fabrics with silicone elastomers to achieve better adhesion and resistance to elongation. This method also allowed the production of partially vulcanized strips that could be bonded by heat pressing.

At the beginning of 1960, following the development of PVC and silicone elastomers, appeared the first flexible heaters for industrial use in the form of ribbons and plates, the main insulation of which was produced by an elastomer resin polymerized or vulcanized around a heating wire. The elastomers used were PVC, rubber, neoprene. Silicone.

There were then woven canvases, made with a sheet whose chain was made of asbestos and the frame of Ni-Cr or constantan, embedded in a silicone gel. These flexible blocks were manufactured in a thickness of 2.5 to 5 mm, in rectangular format (max of 0.90 x 0.20 m) or square (max of 0.50 x 0.50 m), with variable power densities, from 0.4 to 1 W/cm². Their maximum temperature was of the order of 250°C.

In 1960/1961 the final technical solution appeared: the use of non-insulated heating wires sandwiched between sheets of silicone rubber reinforced with glass fibers and then vulcanized. The fiberglass fabric provides mechanical strength; and the silicone electrical insulation and bonding at high temperature; and the vulcanization the indestructible link between these elements. The assembly then forms a waterproof heating sheet. The French manufacturer of warming blankets Méneret could then write: *"all our heating blankets without exception are equipped with special heating wires isolated under totally invisible channels"*.

This technology had no outlet in domestic warming blankets because of the price of silicone resins. In addition, the high temperature resistance was not necessary for this application.

But this technique gave rise to the branch of high temperature flexible flat heaters for industrial applications.

Since then, various ways of producing the heating web have raised.

- Wire wound conductors: the oldest solution, but which gives the greatest flexibility;
- Thin metal sheet etched with acid, a process similar to that of the manufacture of printed circuits, but whose flexibility is limited (Invented around 1969);
- Conductive ink printed circuit, silk screen printed on flexible polymer, quite flexible and cheap, but with low temperature resistance.

High temperature-resistant adhesives (FEP, acrylic) have also emerged which allow to replace the vulcanization of elastomers, and which are particularly suitable for the use of polyester (PET), polyimide (PI) and polycarbonate (PC) sheets, allowing to laminate the various layers of the flexible elements and to realize extremely fine elements (down to 0.2mm for Kapton-type polyimide models).



Introduction technique

Because of permanent improvement of our products, drawings, descriptions, features used on these data sheets are for guidance only and can be modified without prior advice



Contact us

Web: www.ultimheat.com

Cat25-2-2-5



With the arrival on the market of many manufacturers and the spread of sales by internet without any technical specifications, popped up many products, most of time simple visual copies, without any technical validation, and the purchase of which is made most often in view of pictures and of a price.

With this technical introduction, we want to show that our continuous search for improvements and superior technology is the only way to provide our **professional** customers with **reliable and sustainable** solutions, taking into account the multiple technical pitfalls of flexible silicone elements. **Nothing** in the design of our devices was left to chance or approximation. Unless otherwise specified, all tests were performed in Ultimheat laboratory.

Ultimheat is **ISO 9000-2015** and **ISO 14000-2015 certified** (the last existing versions). It is also a government **Certified High Technology Company**.



Silicone heaters, technical introduction

Because of permanent improvement of our products, drawings, descriptions, features used on these data sheets are for guidance only and can be modified without prior advice



Technical introduction summary

1- Comparison of flexible heaters technologies	11
2- Drums reheating.....	12
2- 1. Standardized dimensions of drums.....	12
Usual dimensions of steel drums.....	12
2- 2. Drums reheating with flexible silicone belts	13
Reheating time of drums.....	13
Overheat of flexible silicone heating belts mounted on empty drums.....	13
Comparative practical examples of reheating drums with flexible silicone heating belts.....	14
Comparison of heating times required for different liquids currently heated by silicone belt heaters.....	17
3- Pipes heating	18
3- 1. Pipes surface temperature.....	18
Test results on stainless steel tubes.....	19
Test results on galvanized steel tubes	20
Test results on U-PVC tubes.....	21
4- Boards heating with flexible silicone heaters.....	23
4- 1. Surface temperature of boards as a function of the surface power.....	23
Measurement on flexible silicone heater suspended in air.....	23
Measurement on flexible silicone heaters mounted on non-immersed metal walls.....	24
5- Constructional parameters of flexible silicone heaters.....	25
5- 1. General parameters.....	25
Some modern methods of forming heating wires for flexible silicone heaters.....	25
5- 2. The use of resistive wires with a positive temperature coefficient, null or negative, and consequently, the variation of the power as a function of the temperature.....	26
5- 3. Design of the reinforced silicone sheets.....	26
5- 4. Flexible silicone heaters surface coatings.....	28
5- 5. Mechanical strength of flexible silicone heaters.....	28
Tear strength.....	28
Creeping	29
Holding hooks resistance to tearing.....	30
Split resistance of the vulcanized layers.....	31
Flexing resistance.....	31
Tear strength of silicone protective housings of thermostats, limiters, temperature sensors.....	32
Comparison of the different vulcanization techniques and adhesives used for the bonding of silicone caps on flexible silicone heating surfaces.....	32
5- 6. Connection methods for wires, cables, temperature sensors and thermostats.....	32
Connection of wires on flexible silicone heaters (IP54).....	33
Connection of cables and temperature limiters on flexible silicone heaters (IP65)	33
Connection of cable and temperature sensor on flexible silicone heaters (IP65).....	34
Connection of cable and adjustable bimetal thermostat on flexible silicone heaters (IP54).....	35
Connection of cable and adjustable bulb and capillary thermostat on flexible silicone heaters (IP54).....	35
5- 7. Parameters of electrical insulation of flexible silicone heaters.....	36
Insulation resistance at ambient temperature.....	36
Electric strength at ambient temperature.....	36
Leakage current at working temperature.....	37
5- 8. Rohs and Reach compliance.....	37







Silicone heaters, technical introduction

Because of permanent improvement of our products, drawings, descriptions, features used on these data sheets are for guidance only and can be modified without prior advice



Silicone heaters, technical introduction

1: Comparison of flexible heaters main technologies*

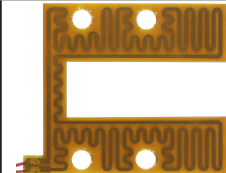
	Heating fabrics		Silicone rubber heaters		Thin insulation foils heaters	
Type	1 Wire wound heating element embedded in fabric	2 Zig-Zag heating wires	3 Wire wound heating element vulcanized inside rubber	4 Etched metal foil vulcanized inside rubber	5 Thick film heaters, silk screen printed	6 Etched foil bonded on insulating film
Picture						
Temperature range	-20+120°C . Usual value as it depends of the fabric used and heating wire insulation. (From -20+120°C for PA66 to -60+350°C for fiberglass or aramide)	-60°C to 230°C.	-60°C to 230°C.	-60°C to 230°C.	-20+80°C. Temperature resistance depends mainly of conductive and resistive inks used. Insulation foil can be PVC or PET or even polyimide. Surface power load limited to 0.2W/cm².	-60 to 230°C. Usual value, as it depends of insulation foil material, adhesive used to bond the foils. Insulation film can be PET (max 120°C due to film material), Kapton (max 230°C due to PSA)
Flexibility	Good resistance to bending and repeated flexing.	Limited resistance to bending and repeated flexing.	The best resistance to repeated flexing.	Limited to static application because poor resistance to flexion of the metal foil.	Very poor resistance of inks to flexion.	Limited to static application because poor resistance to flexion of the metal foil.
Used in	Industrial jacket heaters. Domestic and industrial blanket heaters and heating pads. Heating clothes.	Industrial flexible silicone heaters. Low volume applications.	Industrial flexible silicone heaters, low volume applications	Most of large volume industrial and commercial applications requesting high temperature resistance and high watt/cm²	Low cost and low temperature heaters used in automobile for heating seats or mirrors to keep ice from forming on the side view mirrors of cars, busses and trucks.	Applications that require a lightweight solution or a rapid heat-up time. Wide temperature range when using Kapton
Technology	The oldest technology, dating back to the end of 19th century. The resistive conductor is coiled around fiberglass or aramid core. (It was asbestos until 50 years ago). Then the flat heater can be made using 2 technical solutions: 1/- Heating fabric whose warp yarns are made of fiberglass, cotton aramid, polyimide, and weft yarns are made of this coiled heating wires 2/-Stitching the wires on a fabric. This solution allows to use wires with a primary insulation in silicone or FEP. Then the primary insulation can receive a metal braid, for grounding. This is the single way to produce flexible heaters with a grounding braid, requested in some industrial applications.	The resistive conductor is formed in a flat zig-zag, and assembled in a web. This technology produces heaters without thickness increase , similar to the etched models. The cheapest solution for small quantities, (Technology patented by Ultimheat)	The resistive conductor is coiled around fiberglass or polyimide core. Then a web is made with the coiled wires hand pressed on the un-vulcanized silicone. Then the heating web is vulcanized between 2 sheets of fiberglass reinforced silicone rubber. In their traditional time-consuming assembly process, they are only suited for small quantities. In the Ultimheat patented technology the fiberglass fabric net and the heating wire are computer designed, and heating wire is automatically embedded in the fiberglass net before vulcanizing. This allows fully automated production and large volume applications.	The heating element conductive web is made from a thin metal sheet chemically etched with a technology similar to the printed circuits processing. Then this metallic web can be vulcanized between 2 flexible and insulating sheets. Sheets can be made of any type of rubber or elastomers. Because of the larger paths, smaller spacing between elements and better heat transfer, the power density can be up to 2 time bigger than classical wire wound models. They are suited for medium and large quantities.	Thick film heaters are constructed on silk screening of conductive and resistive inks. These inks are printed on a flexible substrate. They can be produced using an ink that makes the heater capable of self-regulating its temperature or as a fixed resistance heater.	Etched foil Kapton flexible heaters are made with a thin metal foil as the resistance element. The resistance pattern is designed in CAD and transferred to the foil in a process similar to the printed circuits manufacturing. The metal foil is then laminated and bonded to the insulating substrate with adhesive (FEP or Acrylic). The metal foil/substrate is then processed through an acid to produce the etched heating element. The top layer is then added and bonded and laminated with adhesive as done for the first side. Polyimide heater offers dimensional stability and high tensile strength. It is also resistant to most chemicals. (Kapton is a brand name from Dupont for polyimide).

* Types 1, 2, 3, 4 are produced by Ultimheat.



Silicone heaters, technical introduction

2-Drums reheating

2-1. Standardized dimensions of drums

One of the most common applications of flexible silicone heaters is reheating drums. It is therefore necessary to specify the theoretical and practical dimensions.

The most common, the 200-litre drum (known as a 55-gallon drum in the United States and a 44-gallon drum in the United Kingdom) is a cylindrical container with a nominal capacity of 200 litres (55 US or 44 imp gal). The exact capacity may vary by manufacturer, purpose, or other factors. Standard drums have inside dimensions of 572 millimetres (22.5 in) diameter and 851 millimetres (33.5 in) height inside. These dimensions yield a volume of about 218.7 litres (57.8 US gallon; 48.1 Imperial gallon), but they are commonly filled to about 200 litres.

The outside dimensions of a 200-litre drum are typically 584 millimetres (23 in) diameter at the top or bottom rim, 597 millimetres (23.5 in) diameter at the chimes (ridges around drum), and 876 millimetres (34.5 in) height.

The external dimensions are identical to a few millimeters in the US and ISO versions. The nominal diameters of the threads of the bungs on the top cover are identical, but differ in the pitch used:

According to the American standard ANSI MH2, the threads are of type NPT.

According to the international standard ISO 15750 the threads are type G2 "and G¾" (ISO 228-1 standard)

This arrangement is echoed in many plastic drums in the same size. Various components can be mounted to the drum, such as drum pumps and bung mixers.

Dimensions usuelles des fûts métalliques

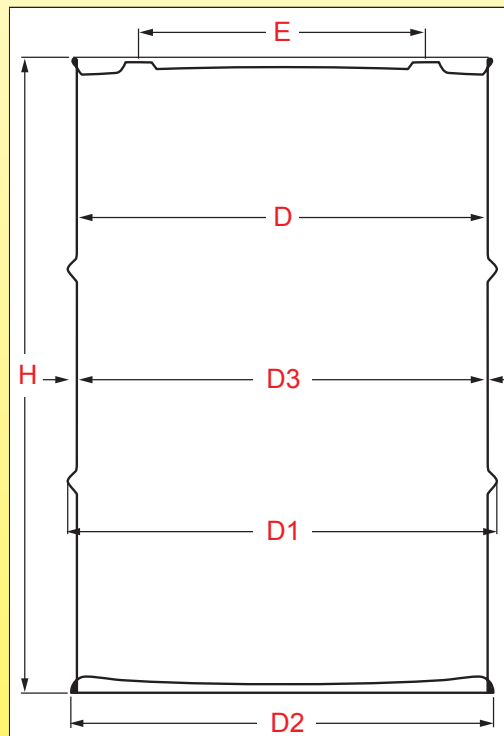

Capacity Liters (US gallons)	Overall height H mm ± 6.4 (in inches ± 1/4)	Inside diameter D in mm ± 3.2 (in inches ± 1/8)	Over-hoop diameter D1 in mm ± 3.2 (in inches ± 1/8)	Over-chime diameter D2 in mm ± 3.2 (in inches ± 1/8)	Outside diameter at no hoop D3 in mm ± 3.2 (in inches ± 1/8)	Distance between fittings centers E in mm (inches)	N° of hoops
19-20 (5)	283 (11-1/8)	356 (14)	371 (14-5/8)	363 (14-5/16)	359 (14-1/8)	210 (8-1/4)	2
30 (8)	412 (16-1/4)	356 (14)	371 (14-5/8)	363 (14-5/16)	359 (14-1/8)	210 (8-1/4)	2
38 (10)	489 (19-1/4)	356 (14)	371 (14-5/8)	363 (14-5/16)	359 (14-1/8)	210 (8-1/4)	2
60 (16)	733 (28-7/8)	356 (14)	371 (14-5/8)	363 (14-5/16)	359 (14-1/8)	210 (8-1/4)	2
75 (20)	552 (21-3/4)	463 (18-1/4)	486 (19-1/8)	475 (18-11/16)	466 (18-3/8)	343 (13-1/2)	2
110/120(30)	749 (29-1/2)	463 (18-1/4)	486 (19-1/8)	475 (18-11/16)	466 (18-3/8)	343 (13-1/2)	2
200/220 (55)	878 (34-1/2)	572 (22-1/2)	593 (23-3/8)	586 (23-1/16)	574 (22-5/8)	444 (17-1/2)	2

For silicone heating belts, the diameter D3 must be taken into account. Under no circumstances should the heating belt be applied to diameters D1 or D2

Because of permanent improvement of our products, drawings, descriptions, features used on these data sheets are for guidance only and can be modified without prior advice



Silicone heaters, technical introduction

2-2. Drums reheating with flexible silicone belts

Reheating time of drums

This is the most common question: How long will it take to heat a drum?

A first approach must take into account a number of critical parameters, and the main ones are:

1-The total volume heated.

For a given power a large volume will heat up less quickly than a small volume

2-The total power applied.

Higher power will in principle warm up faster

3-The distribution of power.

Heating distributed over the whole mass or on all the walls will heat up faster than heating located on a small surface of the tank

4-The thermal conductivity of the liquid.

The higher the thermal conductivity of the liquid, the faster the heat is transmitted to the whole mass

5-The heat capacity of the liquid.

Since the heat capacity represents the energy that must be applied to a mass of liquid to heat it, liquids with a low heat capacity will heat, at equal power, faster than those with a high heat capacity.

6-The kinematic viscosity (ν) of the liquid.

The more viscous a liquid, the fewer convection currents. So the heat energy is transmitted less quickly. It may be necessary in some cases to add a mixing apparatus for viscous, low-conductive products.

7-The thermal insulation.

By eliminating heat losses to the outside, the heat energy is concentrated on the tank. An insulated tank will heat up faster. Insulating jackets are available for all dimensions of drums

8-The type of action of temperature control.

PID-type temperature control reduces the power supplied to the tank nearby the set point, therefore the heating time is increased but the usual overheating of on/off control systems is avoided. Improper positioning of the temperature measuring point, for example in the middle of the heated liquid, increases the risk of overheating of the walls, due to the time taken by the heat energy to reach this central location.

9- Thermal safety devices.

When thermal safeties are installed in the heating systems, they limit the temperature reached by the heating element to prevent its destruction by overheating. This limitation can increase the duration of the heating, in particular when the thermal exchanges with the liquid are bad, because of its thermal conductivity or its viscosity.

10-The heating surface.

Silicone belt heaters only cover a small part of the surface of the tanks. The heating is done by thermal conduction between this small surface and the heated product, and the temperature homogeneity is long to be done. So, every-time it is possible, the silicone heater surface should be increased to the maximum.

Overheat of flexible silicone heating belts mounted on empty drums

We strongly discourage this use, as the wall temperatures reached are almost always higher than the silicone belt destruction temperature. If, despite all, this can happens in the application, we recommend the use of a surface temperature control system (eg limiter at 190°C), in addition to the electronic or mechanical thermostat control, and a limitation of the surface power density at 0.75W / cm²

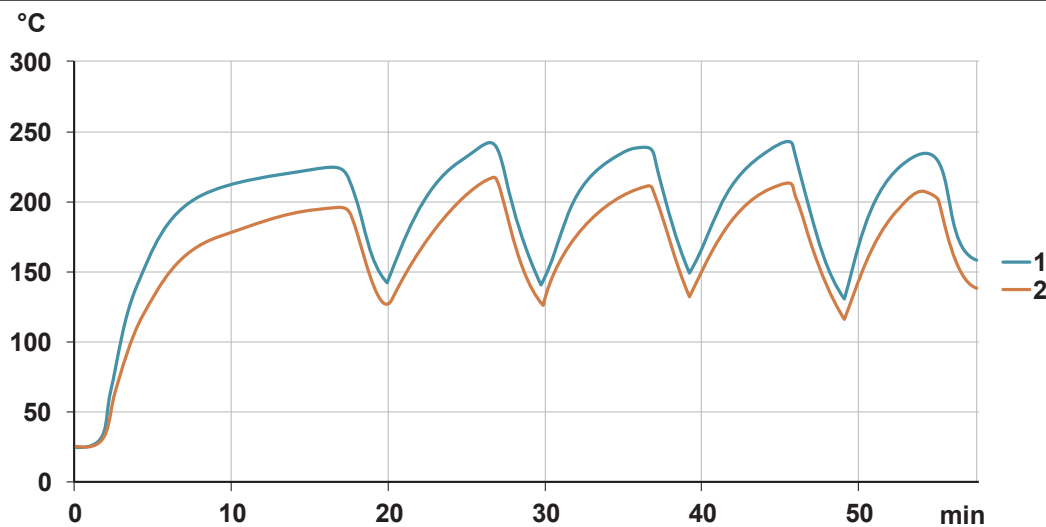

Temperature measurement made on a 200mm width silicone belt mounted on a 55 gallons (200 liters) drum. Power 2250W (0.75W/cm²), PID controller with sensor located in the center of the empty tank. Surface temperature limited to 190°C by a disc thermostat.

1: Temperature of the inner wall of the heating belt
2: Temperature of the outer wall of the heating belt.

Despite the action of the temperature limiter, the surface temperature varies between 220 and 240°C, so it is potentially destructive. The electronic temperature controller temperature sensor being located inside the empty barrel, it does not measure the temperature rise of the wall, and its regulating action does not occur.



Silicone heaters, technical introduction

Comparative practical examples of reheating drums with flexible silicone heating belts

Temperature control by mechanical bulb and capillary thermostat mounted on the surface. The set point of 90°C has been selected to avoid bringing water to boiling point. (Without surface temperature limiter)



Variation in the temperature versus time of a 220-liter metal drum, filled with water, heated by a silicone heating belt 200mm wide, without thermal insulation, power 2250W (surface load 0.75W/cm²).

Variation in the temperature versus time of a 220-liter metal drum, filled with HF 24-6 hydraulic oil, heated by a silicone heating belt 200mm wide, without thermal insulation, power 2250W (surface power load 0.75W/cm²).

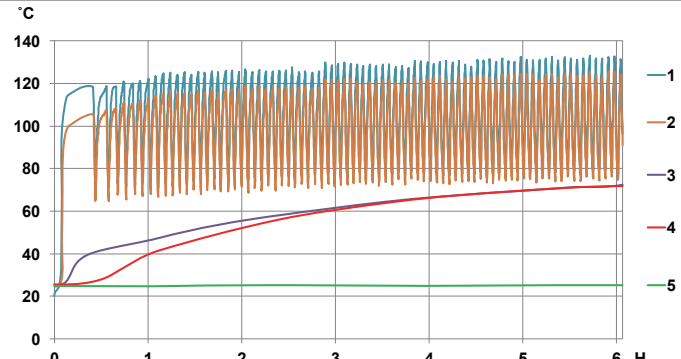
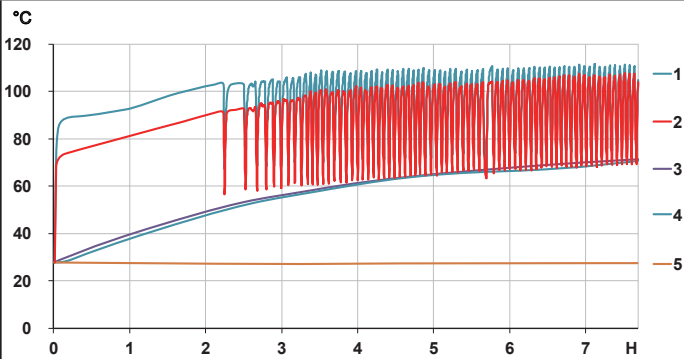

- 1: Surface temperature between silicone belt and drum
- 2: Outside silicone belt surface temperature
- 3: Water temperature, at diameter center, at 50mm from the top
- 4: Water temperature, at diameter center, at half height of the drum
- 5: Water temperature, at diameter center, at 50mm from the bottom

- 1: Surface temperature between silicone belt and drum
- 2: Outside silicone belt surface temperature
- 3: Oil temperature, at diameter center, at 50mm from the top
- 4: Oil temperature, at diameter center, at half height of the drum
- 5: Oil temperature, at diameter center, at 50mm from the bottom

Analysis of the results: It is noted in these tests that the temperature difference between the middle and the top of the tank is almost zero. The bottom of the tank does not heat up. The heating time is 7:30 minutes before the temperature of the liquid at the level of the heating belt reaches 70°C. Operation of the thermostat set at 90°C results in wide temperature oscillations at the heating belt walls

Energy efficiency is very low (35%) compared to insulated heating coats that can reach 85 to 90%.

Analysis of the results: It is noted in these tests that the temperature difference between the middle and the top of the tank is quickly becoming null. The bottom of the tank does not heat up. The heating time is 5 hours before the temperature of the liquid at the level of the heating belt reaches 70°C. Operation of the thermostat set at 90°C results in wide temperature oscillations rising up to 130°C at the heating belt walls

Energy efficiency is very low (32%) compared to insulated heating coats that can reach 85 to 90%.

Because of permanent improvement of our products, drawings, descriptions, features used on these data sheets are for guidance only and can be modified without prior advice



Silicone heaters, technical introduction

Heating with electronic remote control, by PID controller, set point set to 90°C, Pt100 sensor mounted on the surface of the heating belt. (Without surface temperature limiter)



Variation in the temperature versus time of a 220-liter metal drum, filled with water, heated by a silicone heating belt 200mm wide, without thermal insulation, power 1500W (surface load 0.5W/cm²).

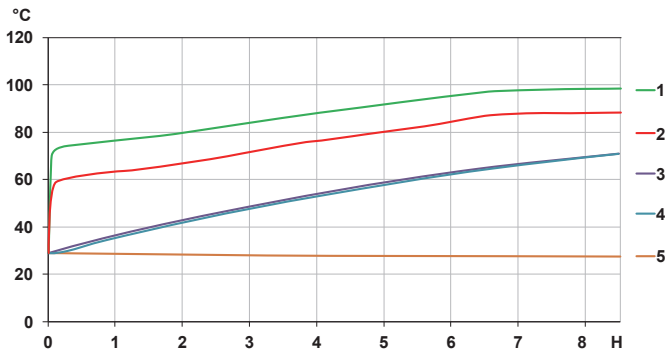

- 1: Surface temperature between silicone belt and drum
- 2: Outside silicone belt surface temperature
- 3: Water temperature, at diameter center, at 50mm from the top
- 4: Water temperature, at diameter center, at half height of the drum
- 5: Water temperature, at diameter center, at 50mm from the bottom

Analysis of the results: It is noted in these tests that the temperature difference between the middle and the top of the tank is almost zero. The bottom of the tank does not heat up. The heating time is 8:30 minutes before the temperature of the liquid at the level of the heating belt reaches 70°C.

Energy efficiency is very low (30%) compared to insulated heating coats that can reach 85 to 90%

Variation in the temperature versus time of a 220-liter metal drum, filled with HF 24-6 hydraulic oil, heated by a silicone heating belt 200mm wide, without thermal insulation, power 1500W (surface power load 0.5W/cm²).

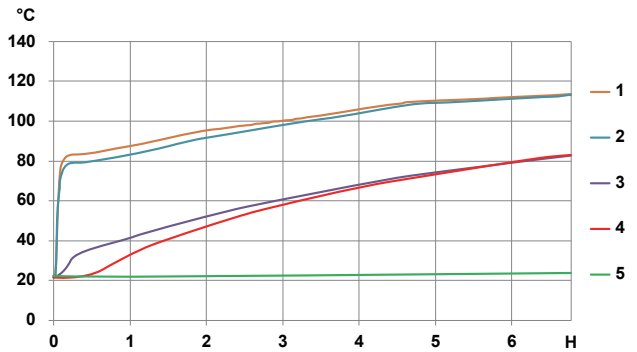

- 1: Surface temperature between silicone belt and drum
- 2: Outside silicone belt surface temperature
- 3: Oil temperature, at diameter center, at 50mm from the top
- 4: Oil temperature, at diameter center, at half height of the drum
- 5: Oil temperature, at diameter center, at 50mm from the bottom

Analysis of the results: It is noted in these tests that the temperature difference between the middle and the top of the tank is almost zero. The bottom of the tank does not heat up. The heating time is 4:30 minutes before the temperature of the liquid at the level of the heating belt reaches 70°C. This is only 55% of the time used to heat water in the same conditions.

Energy efficiency is very low (30%) compared to insulated jacket heaters that can reach 85 to 90%

Because of permanent improvement of our products, drawings, descriptions, features used on these data sheets are for guidance only and can be modified without prior advice



Silicone heaters, technical introduction

Heating with electronic remote control, PID action regulator, Pt100 sensor immersed in the center of the tank, surface temperature of the heating belt **protected by a bimetal disc temperature limiter set at 190°C** to prevent destruction of the heating element by overheating.



Variation in the temperature versus time of a 220-liter metal drum, filled with water, heated by a silicone heating belt 200mm wide, without thermal insulation, power 2250W (surface load 0.75W/cm²).

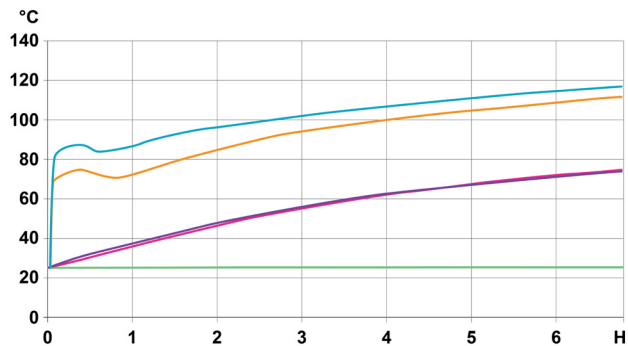

- 1: Surface temperature between silicone belt and drum
- 2: Outside silicone belt surface temperature
- 3: Water temperature, at diameter center, at 50mm from the top
- 4: Water temperature, at diameter center, at, half height of the drum
- 5: Water temperature, at diameter center, at 50mm from the bottom

Analysis of the results: It is noted in these tests that the temperature difference between the middle and the top of the tank are very quickly identical, while the bottom of the tank is absolutely not warmed. The heating time is 6 hours 30 minutes for the temperature of the liquid at the level of the heating belt reaches 70 °C.

Energy efficiency is very low (35%) compared to insulated heating coats that can reach 85 to 90%

Variation in the temperature versus time of a 220-liter metal drum, filled with HF 24-6 hydraulic oil, heated by a silicone heating belt 200mm wide, without thermal insulation, power 2250W (surface power load 0.75W/cm²).

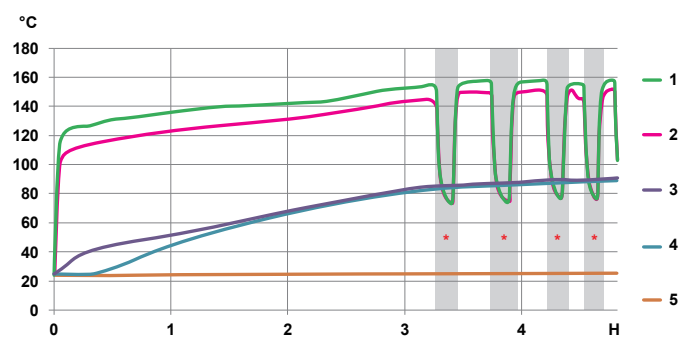

- 1: Surface temperature between silicone belt and drum
- 2: Outside silicone belt surface temperature
- 3: Oil temperature, at diameter center, at 50mm from the top
- 4: Oil temperature, at diameter center, at, half height of the drum
- 5: Oil temperature, at diameter center, at 50mm from the bottom

Analysis of the results: It is noted in these tests that the temperature difference between the middle and the top of the tank are very quickly identical, while the bottom of the tank is absolutely not warmed. It takes 2h30 minutes for the temperature of the liquid at the level of the heating belt to reach 70°C.

Compared with the heating of the water under the same conditions, the time saving is important (ratio of 0.4)

But the surface temperature of the heating element reaches the limit of 190°C because of the low thermal conductivity of the oil and its lower heat capacity. The surface temperature limiter is essential (The zones * are the periods when the limiter has cut off the supply of the heating element).

Energy efficiency is very low (25%) compared to insulated jacket heaters that can reach 85 to 90%.

Because of permanent improvement of our products, drawings, descriptions, features used on these data sheets are for guidance only and can be modified without prior advice



Silicone heaters, technical introduction

Comparison of heating times required for different liquids currently heated by silicone belt heaters.

In order to give an idea to the users heating specific products, we carried out, under identical test conditions, comparative tests by recording the necessary time and the evolution of the temperature during the heating of a liter of product, from 20 °C to 90 °C (measured at the geometric center of the tank). These tests were made with two different values of surface power load: 0.1W/cm² and 0.4W/cm².

Test conditions: Heating performed in a cylindrical tank diameter 76 mm height 280 mm, flat bottom, red copper 2 mm thick, the entire cylindrical portion filled with the product (250 mm) is heated by a flexible silicone heater, insulated with 20mm of PVC-NBR foam. The heating is made without temperature control or safety temperature limiter. The ambient temperature is maintained at 20 °C. in a climatic chamber. The test is stopped when the temperature at the center of the product has reached 90 °C.



Testing equipment

Characteristics of the products used in the tests

Products	Thermal conductivity W/m.K	Specific heat capacity (kJ/kg.K)	Kinematic viscosity at 20 °C mm ² /s	Specific gravity Kg/m ³
Water	0.597@20°C	4.182	1.006@20°C	0.998@20°C
Olive oil	0.189@15°C	1.25	91.5@20°C	0.922 @20°C
Lard	0.407@25°C	2.1	Frozen (melting between 35 and 42 °C)	0.924-0.930
Mineral oil ISO VG680	0.134@40°C	1.99	4000@20°C	0.850
Butter	0.197 @46°C	2.3	Frozen (melting between 27 and 32 °C)	0.87-0.93

With a surface load of 0.1W/cm² (60W)

With a surface load of 0.4W/cm² (240W)

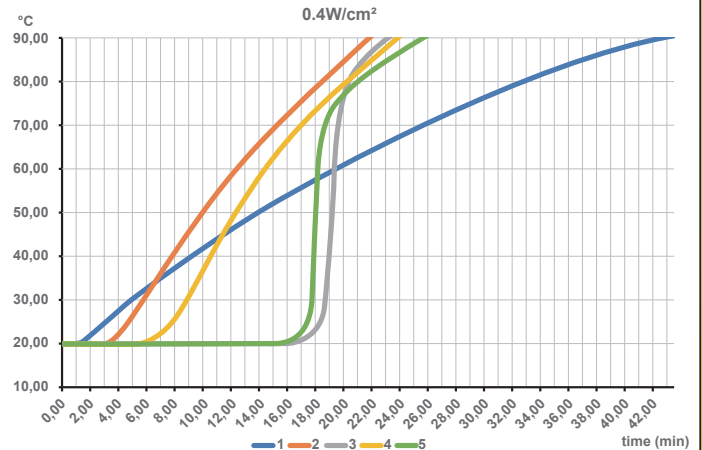
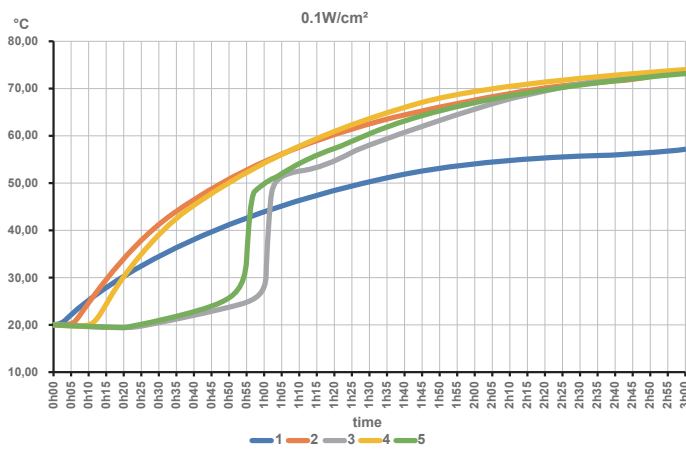

1: Water 2: Olive oil 3: Lard 4: ISO VG680 Mineral oil 5: Butter

Analysis of the results: The water, with a heating capacity of 2 to 4 times greater than the other products, thus requires more energy to warm up and thus heats up much less quickly. Products frozen at room temperature (butter, animal fat) retain for a long time a central cold part for lack of convection currents, before quickly reaching the temperature of the other oils when they liquefy.

Because of permanent improvement of our products, drawings, descriptions, features used on these data sheets are for guidance only and can be modified without prior advice



3- Pipes heating

3-1 Pipes surface temperature

A second application of flexible silicone heaters is heating or antifreeze protection of the pipes. The temperature reached on the pipe surface is the most important parameter. We have therefore performed a number of tests to allow users to have benchmarks before selecting a flexible silicone heater for these applications.



Condition of the comparative tests: Silicone heating ribbons wound on tubes of external diameter 25mm, in PVC-U, galvanized steel and stainless steel

In order to characterize the power requirements, comparative tests under different conditions have been carried out. The heating was carried out by a flexible silicone ribbon wound on the tube with a pitch equal to twice its width, thus covering half of the surface of the tube. The power in W/cm^2 provided in the test results is that of the heating tape. It must therefore be divided by 2 to relate it to the surface of the tube. In blue the wall temperature of the tube outside areas covered by the heating tape. In red the wall temperature of the tube in the areas covered by the heating tape. Measurement was made at an ambient temperature of 25°C.

Because of permanent improvement of our products, drawings, descriptions, features used on these data sheets are for guidance only and can be modified without prior advice

Silicone heaters, technical introduction

Test results on stainless steel tubes

Because of permanent improvement of our products, drawings, descriptions, features used on these data sheets are for guidance only and can be modified without prior advice

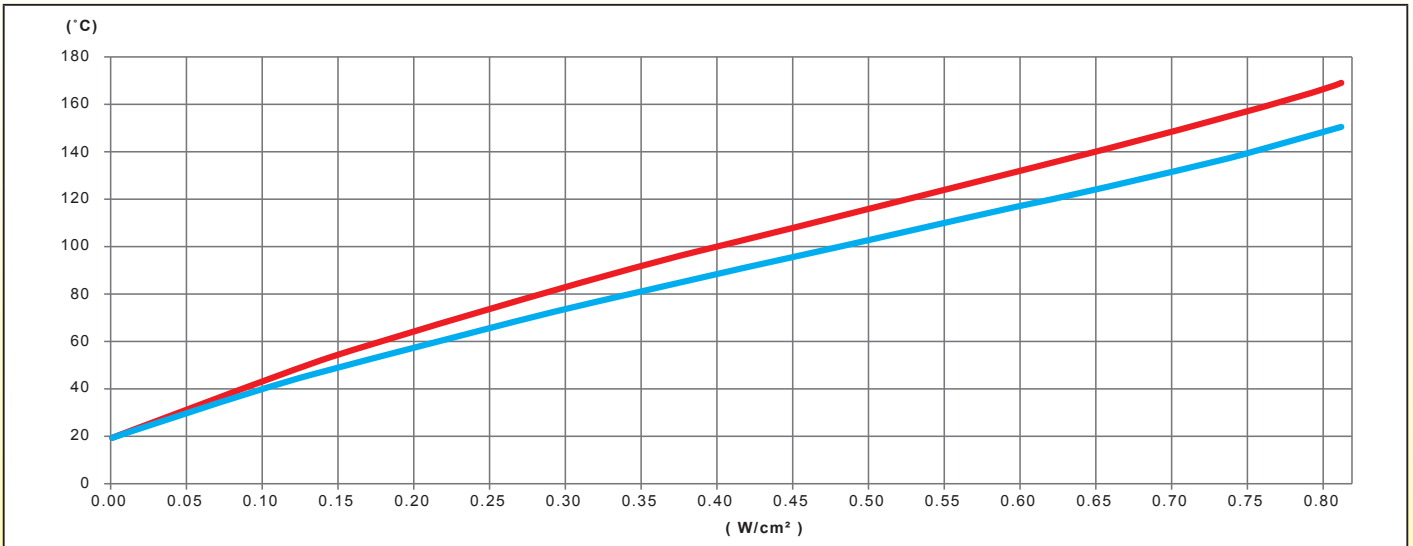

Variation, as a function of the power in W/cm² of the silicone heating ribbon, of the wall temperature of an **empty, non-thermally insulated stainless steel tube**

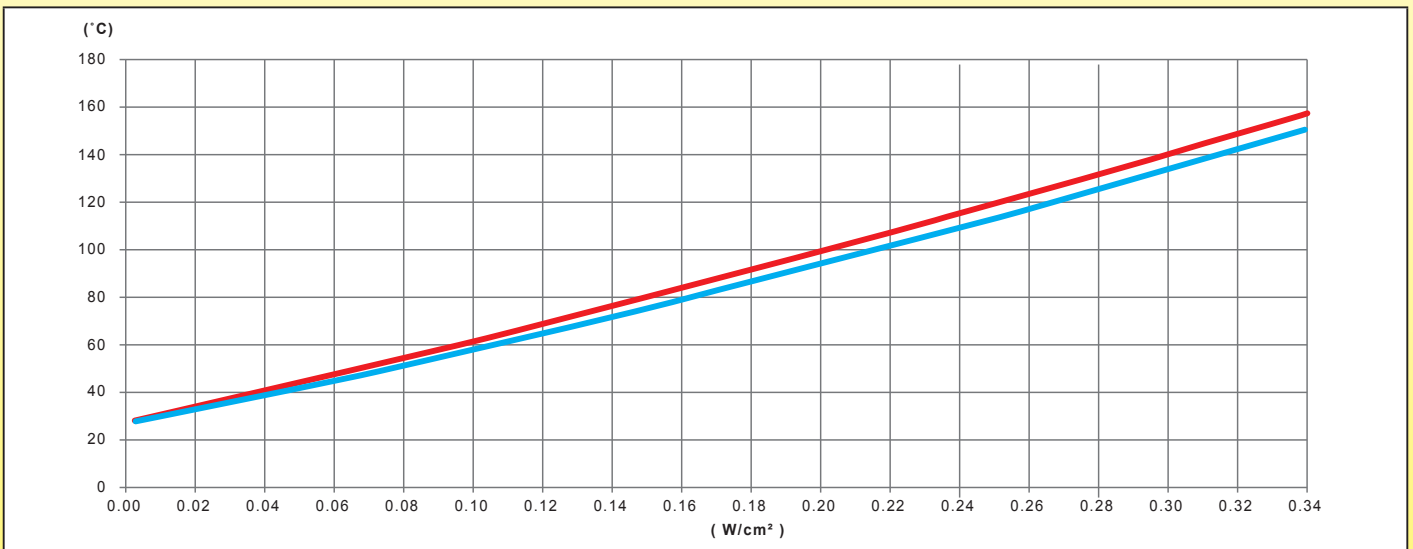

Variation, as a function of the power in W/cm² of the silicone heating ribbon, of the wall temperature of an **empty stainless-steel tube, thermally insulated by 20mm of PVC-NBR foam**

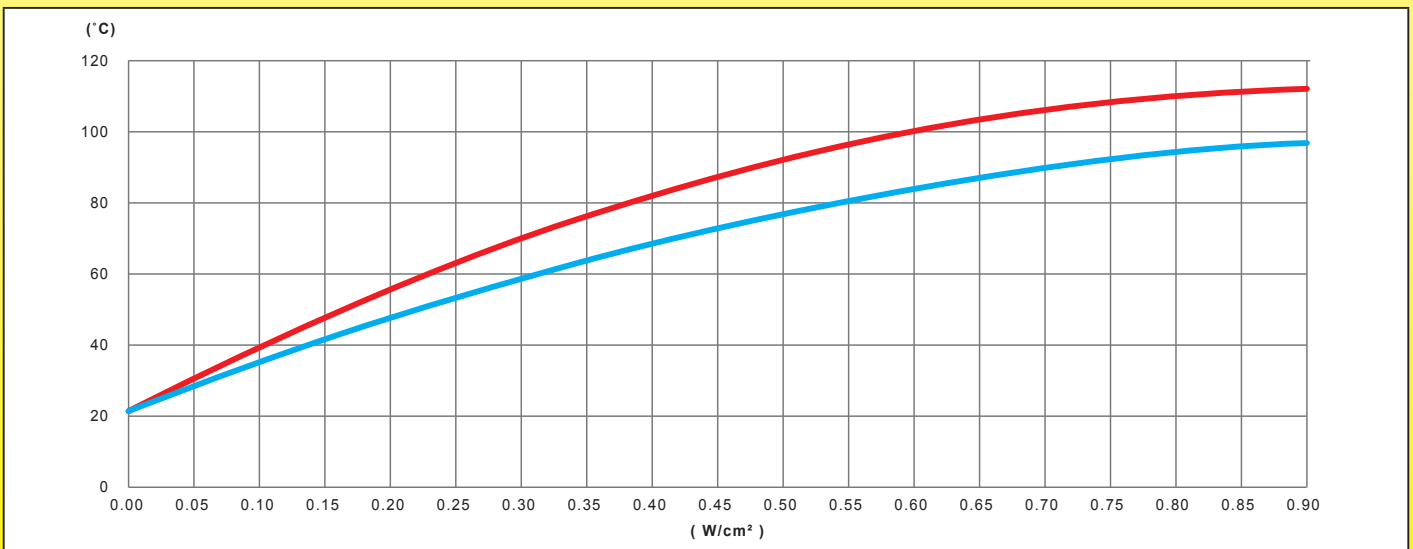

Variation, as a function of the power in W/cm² of the silicone heating ribbon, of the wall temperature of a **stainless-steel tube, filled with non-circulated water, no-thermally insulated**



Contact us

Web: www.ultimheat.com

Cat25-2-2-19

Silicone heaters, technical introduction

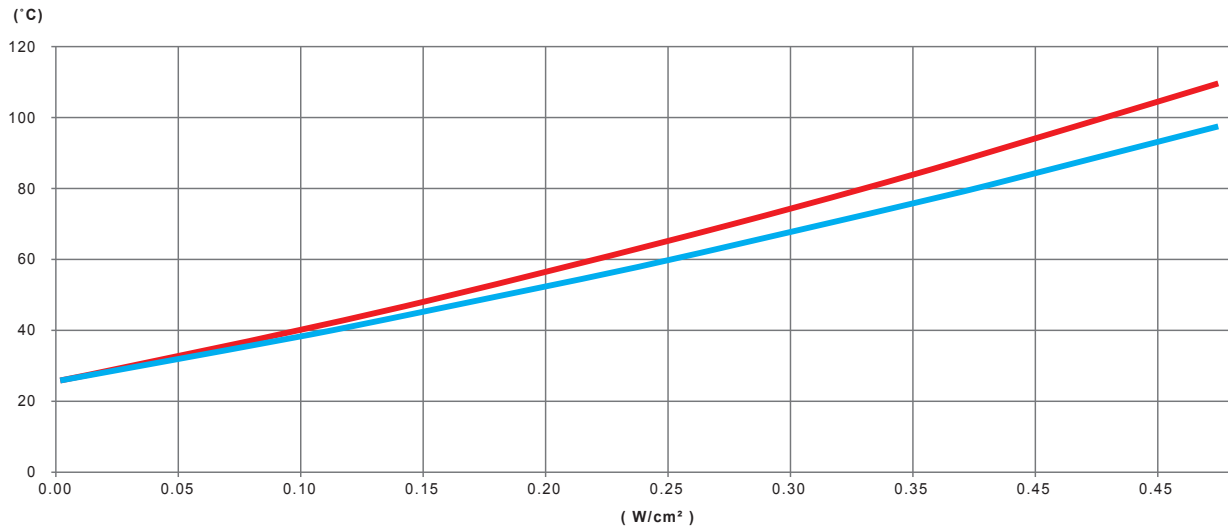

Variation, as a function of the power in W/cm² of the silicone heating ribbon, of the wall temperature of a stainless-steel tube, filled with non-circulated water, thermally insulated by 20mm of PVC-NBR foam

Results analysis:

- **Homogeneity of temperature:** the stainless-steel tubes being rather bad heat conductors, one notices strong differences of temperature between the heated zones and the not heated zones, in particular for empty tubes. This difference is attenuated during the use of insulated tubes.
- **Recommended power:** For uninsulated stainless-steel pipes with non-circulating water, such as domestic water supply pipes, a value of 0.42 W/cm² is sufficient to protect against freezing up to -20°C. For insulated tubes, this value is 0.3 w/cm²

Test results on galvanized steel tubes

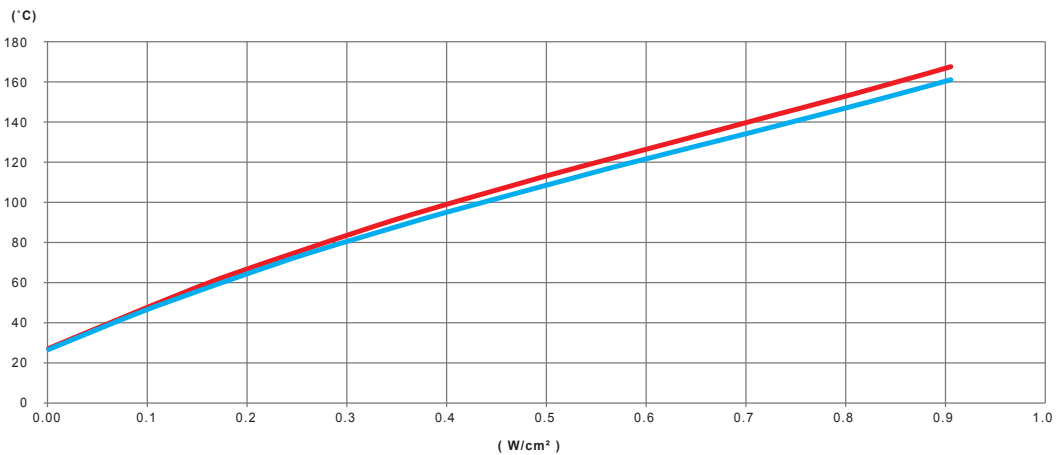

Variation, as a function of the power in W/cm² of the silicone heating ribbon, of the wall temperature of an empty, non-thermally insulated galvanized steel tube

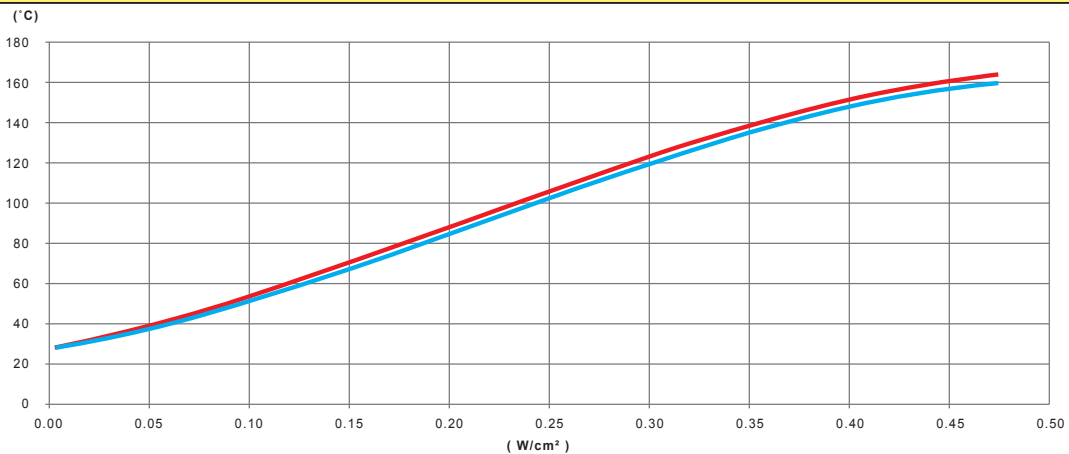

Variation, as a function of the power in W/cm² of the silicone heating ribbon, of the wall temperature of an empty, galvanized steel tube, thermally insulated by 20mm PVC-NBR foam

Because of permanent improvement of our products, drawings, descriptions, features used on these data sheets are for guidance only and can be modified without prior advice



Silicone heaters, technical introduction

Because of permanent improvement of our products, drawings, descriptions, features used on these data sheets are for guidance only and can be modified without prior advice

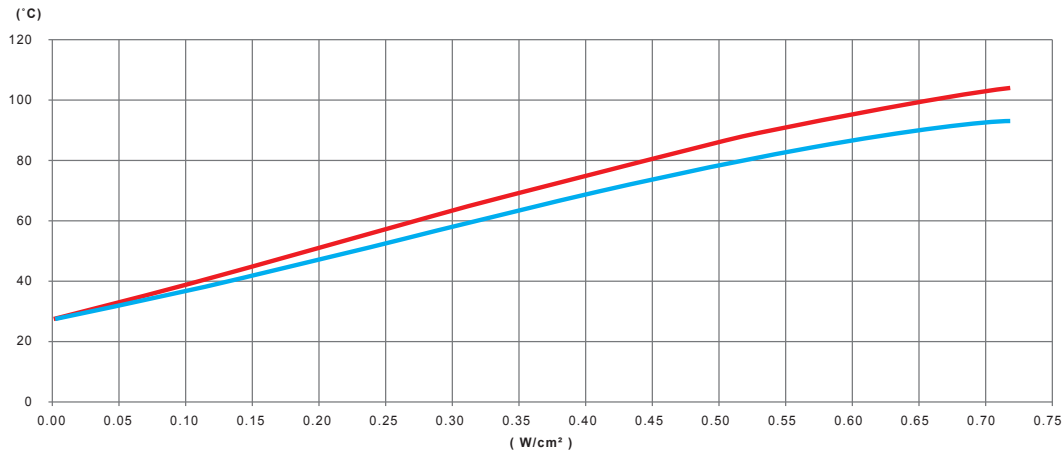

Variation, as a function of the power in W/cm² of the silicone heating ribbon, of the wall temperature of a galvanized steel tube filled with non-circulating water, non-thermally insulated

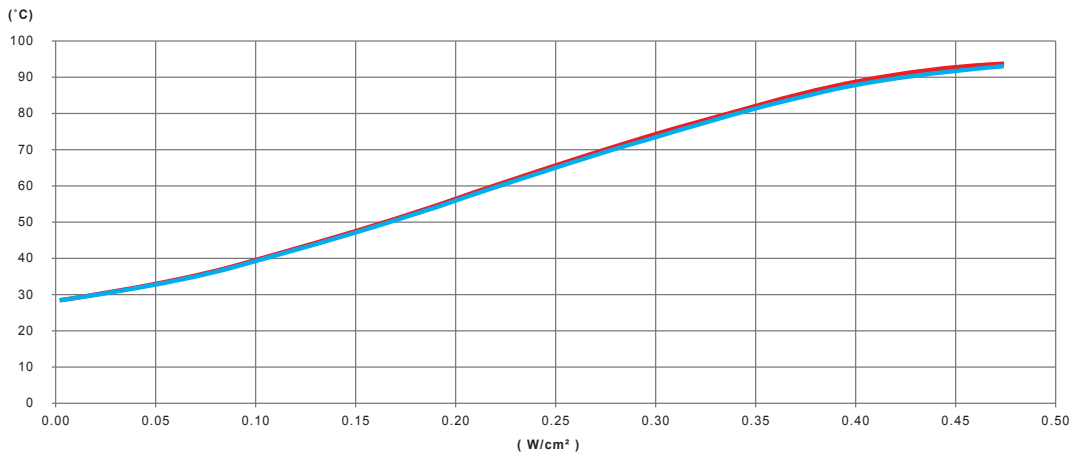

Variation, as a function of the power in W/cm² of the silicone heating ribbon, of the wall temperature of a galvanized steel tube filled with non-circulating water, thermally insulated by 20mm PVC-NBR foam

Results analysis:

- **Homogeneity of temperature:** The steel tubes being fairly good heat conductors, we note a good homogeneity of temperature between the heated zones and the unheated zones, the two becoming almost identical in the isolated tubes.
- **Recommended power:** For non-insulated steel pipes with mostly non-circulating water, such as domestic water supply pipes, a value of 0.4 W/cm² is sufficient to protect against freezing up to -20°C. For insulated tubes, this value is 0.27 W/cm²

Test results on U-PVC tubes

The heating of the plastic pipes is limited by their softening temperature.

It is important to note that if the PVC tube is likely to be empty during the warm-up period, the temperature under the silicone heater ribbon must remain below this softening temperature, which is between 80 and 100°C depending of the type of PVC. (PVC, U-PVC, C-PVC).

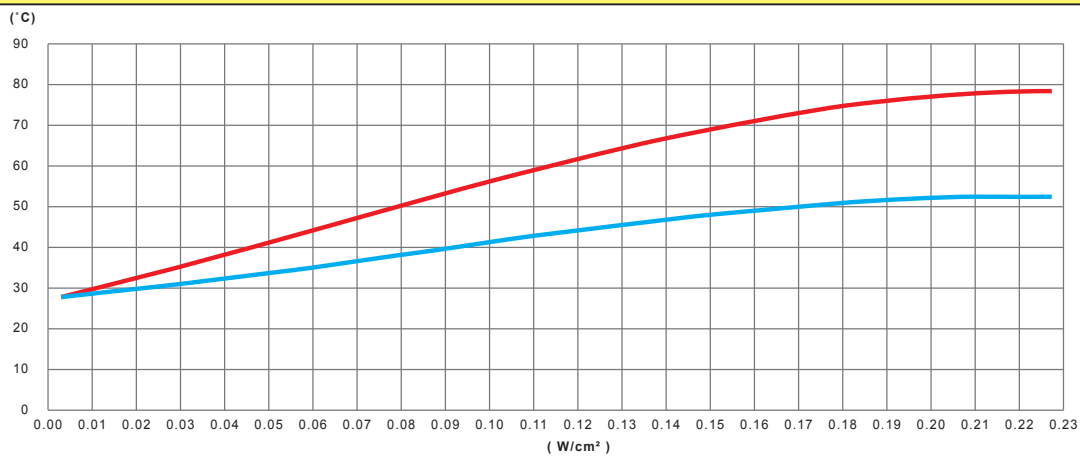

Variation, as a function of the power in W/cm² of the silicone heating ribbon, of the wall temperature of an empty, non-thermally insulated PVC tube



Silicone heaters, technical introduction

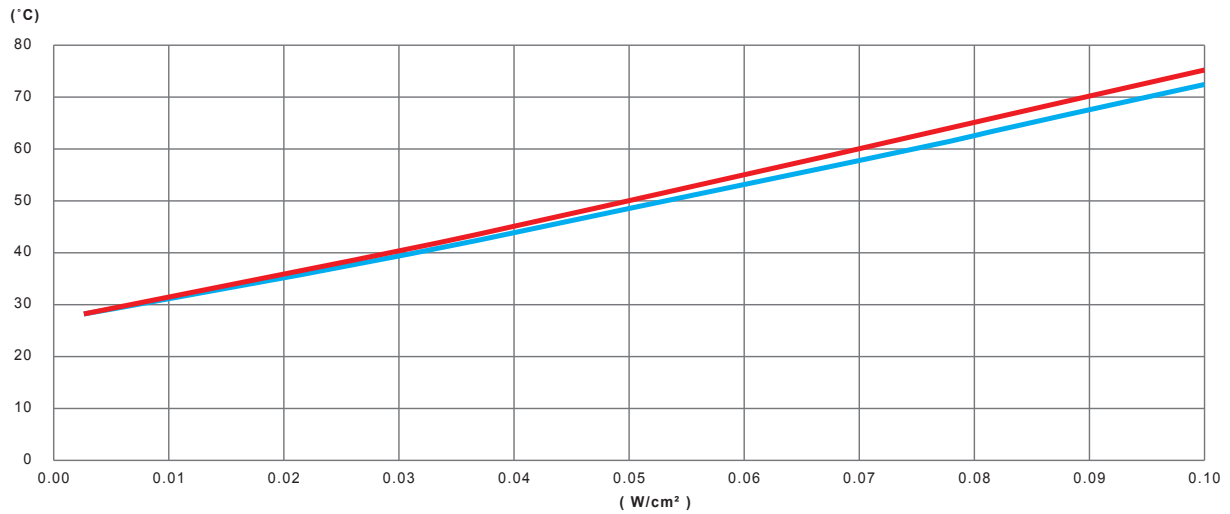

Variation, as a function of the power in W/cm² of the silicone heating ribbon, of the wall temperature of an empty PVC tube, thermally insulated by 20mm of PVC-NBR foam

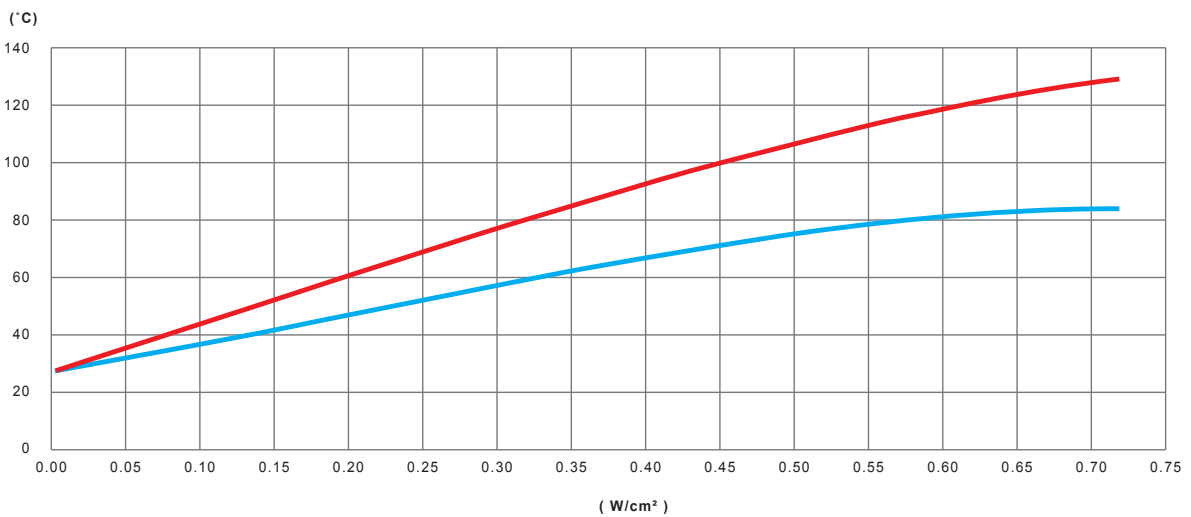

Variation, en fonction de la puissance en W/cm² du ruban chauffant en silicone, de la température de paroi d'un tube en PVC rempli d'eau non circulante, non isolé thermiquement

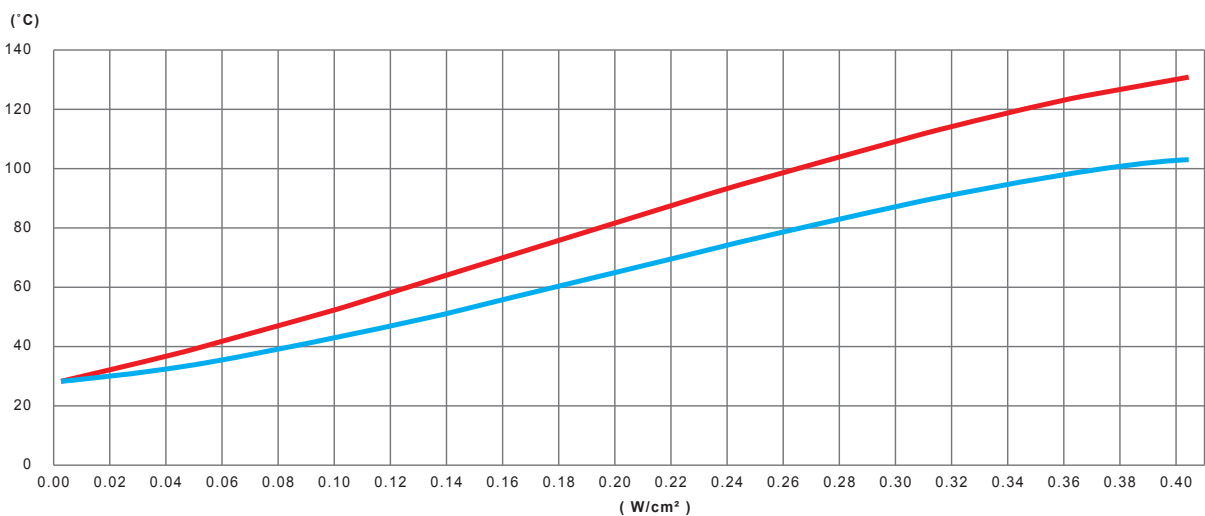

Variation, as a function of the power in W/cm² of the silicone heating ribbon, of the wall temperature of a PVC tube filled with non-circulating water, non-thermally insulated

Results analysis:

- **Homogeneity of temperature:** PVC pipes being poor heat conductors, there is a very large difference in temperature between the heated zones and the unheated zones, which weakens in the insulated tubes but still reaches more than 20°C.
- **Recommended power:** For PVC or U-PVC pipes insulated with non-circulating water, such as domestic water supply pipes, a value of 0.45 W/cm² is sufficient to protect against frost up to -20°C. For insulated tubes, this value is 0.22 W/cm².



Silicone heaters, technical introduction

4-Boards heating with flexible silicone heaters

4-1. Surface temperature of boards as a function of the surface power

Depending on the surface power in W/cm^2 , the temperature of a heated board will stabilize at different values. This temperature, will vary according to the level of its thermal exchanges with its environment. (In calm air, in ventilated air, in contact with boards made of different metals or plastics). The tests below intend to provide a general idea of the evolution of this temperature. (Non-contact measurements made by thermography).

Measurement on flexible silicone heater suspended in air

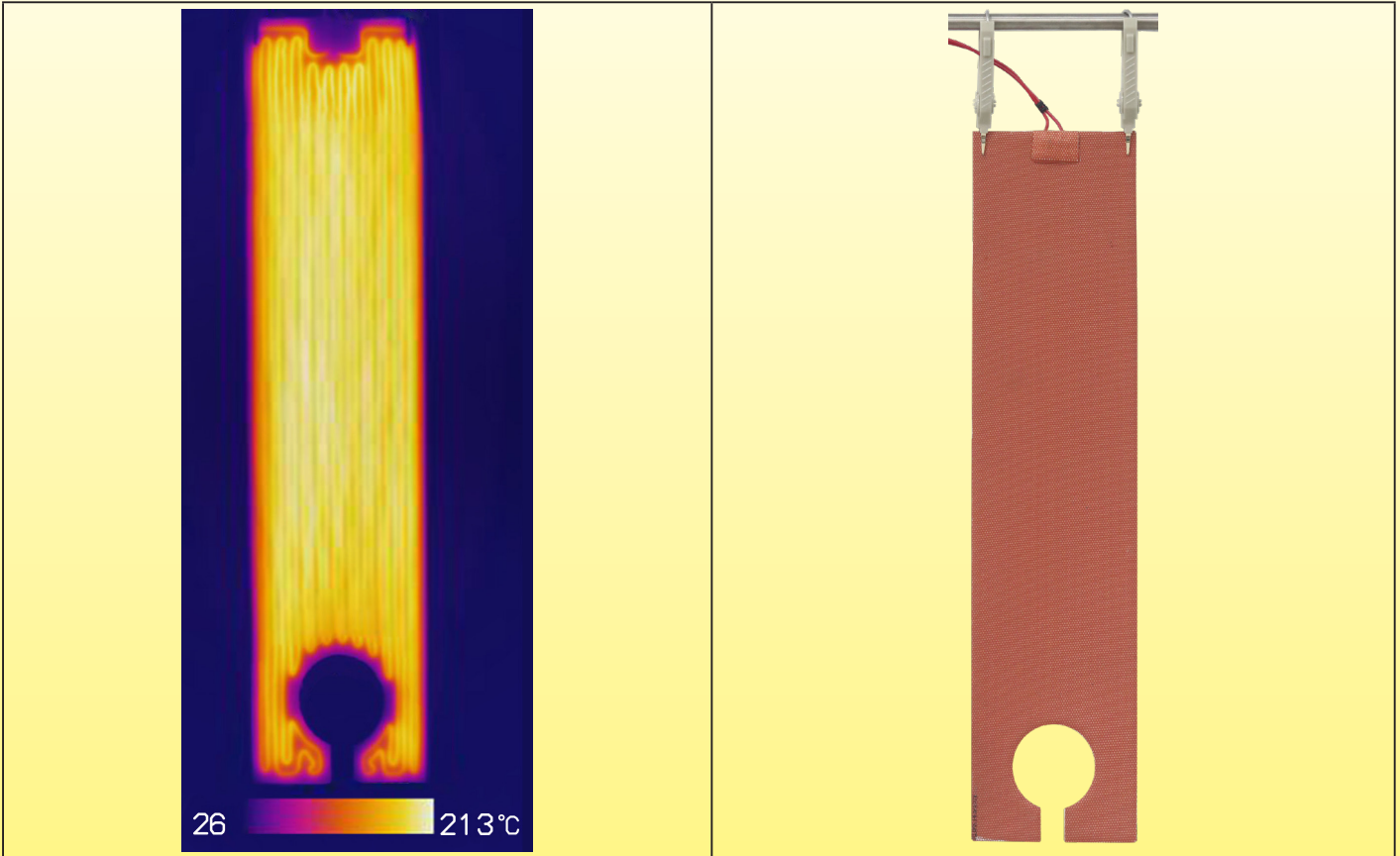

Thermographic image of a 2.4 mm flat silicone heater with a $1W/cm^2$ surface power load, suspended in calm air, not fixed on a board, at an ambient temperature of $25^\circ C$. The surface temperature reaches $213^\circ C$, nearby its destruction.

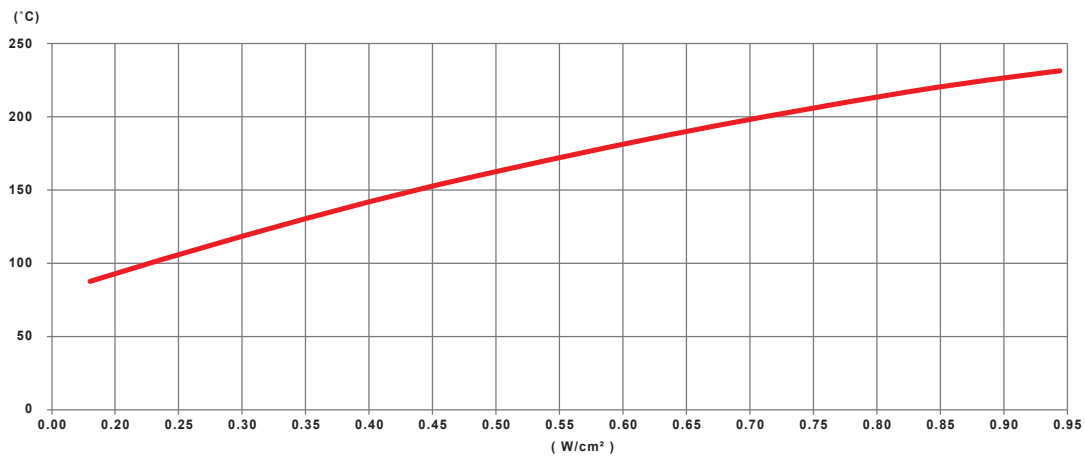

Variation of the surface temperature of a 2.5mm thick silicone heater versus the surface power load. The heater is suspended in calm air, not fixed on a metal surface, at an ambient temperature of $25^\circ C$. The heater is not protected by a temperature limitation system. In these conditions, the heater is irreversibly damaged at $235^\circ C$.

Because of permanent improvement of our products, drawings, descriptions, features used on these data sheets are for guidance only and can be modified without prior advice



Contact us

Web: www.ultimheat.com

Cat25-2-2-23

Silicone heaters, technical introduction

Measurement on flexible silicone heaters mounted on non-immersed metal walls

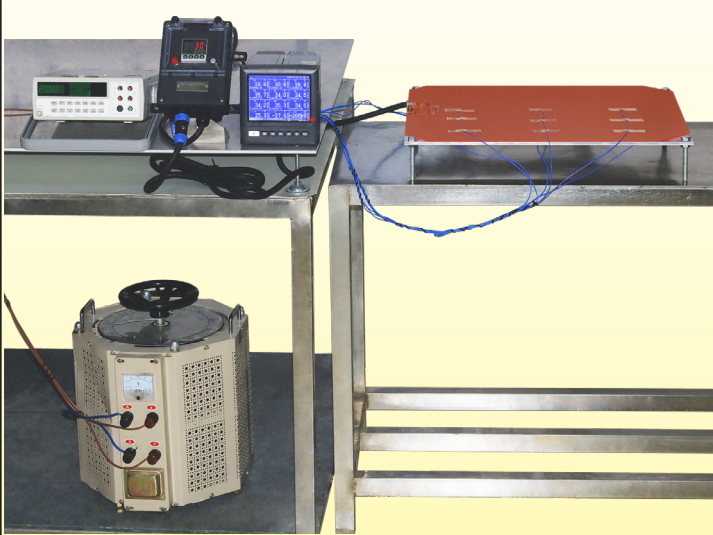
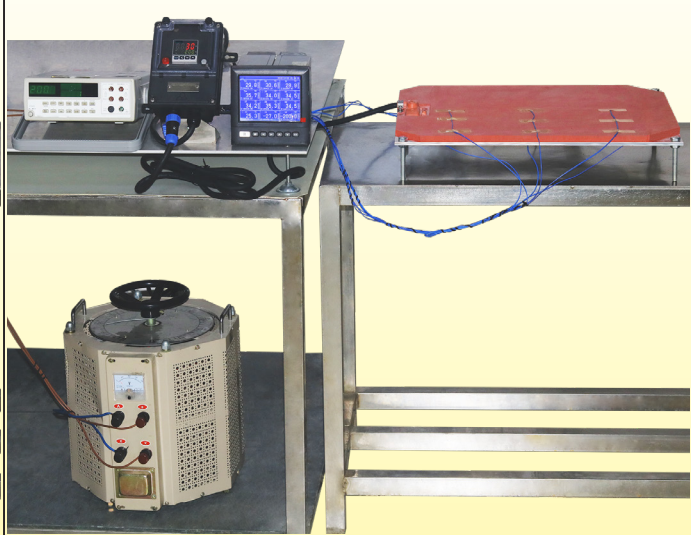
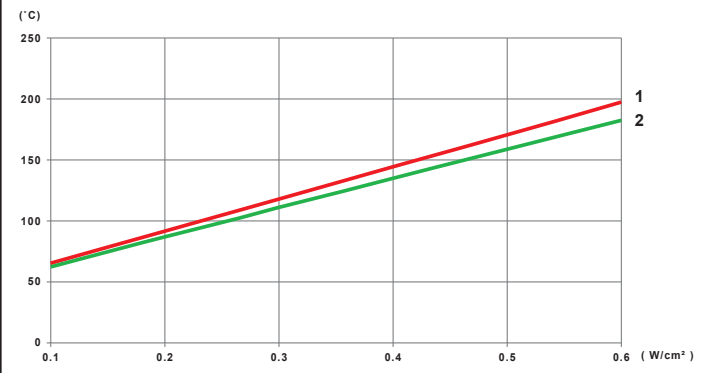
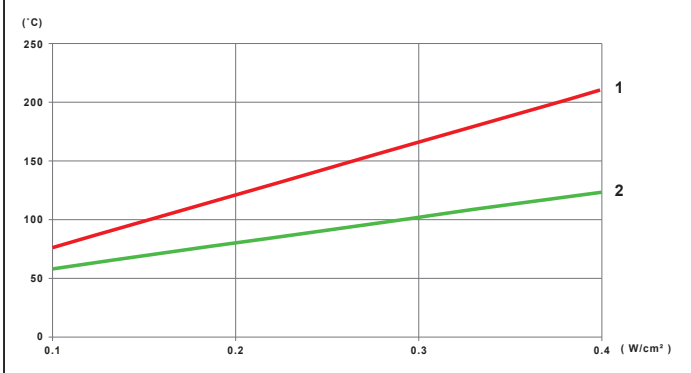
Without thermal insulation	With 10mm silicone foam thermal insulation
	
	
<p>1: Average surface temperature of the aluminium plate 2: Average temperature of the outside surface of the silicone heater.</p>	<p>1: Average surface temperature of the aluminium plate 2: Average temperature of the outside surface of outside surface of then insulation foam.</p>
<p>Variation of the surface temperature versus the surface power load of a 2.5mm thickness silicone heater vulcanized on a flat 6mm thickness aluminum plate. The ambient temperature is 25°C. The aluminum plate reaches a surface temperature of 195°C for a 0.6W/cm² surface load density. The temperature difference between aluminium plate and outside surface of the silicone heater stays limited</p>	<p>Variation of the surface temperature versus the surface power load of a 2.5mm thickness silicone heater vulcanized on a flat 6mm thickness aluminum plate. A 10mm thickness silicone insulation foam is vulcanized on the silicone heater. The ambient temperature is 25°C. The aluminum plate reaches a surface temperature of 210°C for a 0.4W/cm² surface load density. Temperature difference between the 2 faces reaches 90°C at 0.4W/cm²</p>

Because of permanent improvement of our products, drawings, descriptions, features used on these data sheets are for guidance only and can be modified without prior advice



5- Constructional parameters of flexible silicone heaters

5-1. General parameters

The main characteristics of silicone heating resistors are: flexibility and the possibility to produce a high surface power density. The consequences of these characteristics have a major influence on the construction methods.

1- To obtain high heating powers, low electrical resistance heaters are required because the power is equal to U^2/R , so for a given voltage the resistance is inversely proportional to the power.

2- To maintain flexibility, the heating conductors must be of the smallest possible diameter, and arranged in a configuration that facilitates bending.

3- To obtain a good homogeneity of temperature, it is necessary to have the greatest length of wire per unit of surface.

4- To avoid hot spots and the destruction of the vulcanized silicone sheet around the heating wire, it is necessary that the surface power remains as low as possible so that its surface temperature remains below that supported by the silicone.

We see that these parameters 2, 3 and 4 are a priori incompatible with the parameter N°1, and that the manufacture of flexible heaters resistors of high power seems impossible. But the manufacturers of heating wires have mainly developed alloys with high resistivity to reduce the length required, as it is the most economical solution.

So the only remaining parameters that can be modified are:

- The wire forming technology (Small diameter coil around a fiberglass core, zig-zag flat spring, sinusoidal flat spring),
- The assembly of several circuits in parallel in order to divide the power per circuit,
- The selection of heating wires in special low resistivity alloys.

It is the combination of these technical solutions, studied on a case-by-case basis, which guarantees good flexibility and a good density of heating wires per unit area and therefore a good homogeneity of temperature without hot spots.

Some modern methods of forming heating wires for flexible silicone heaters

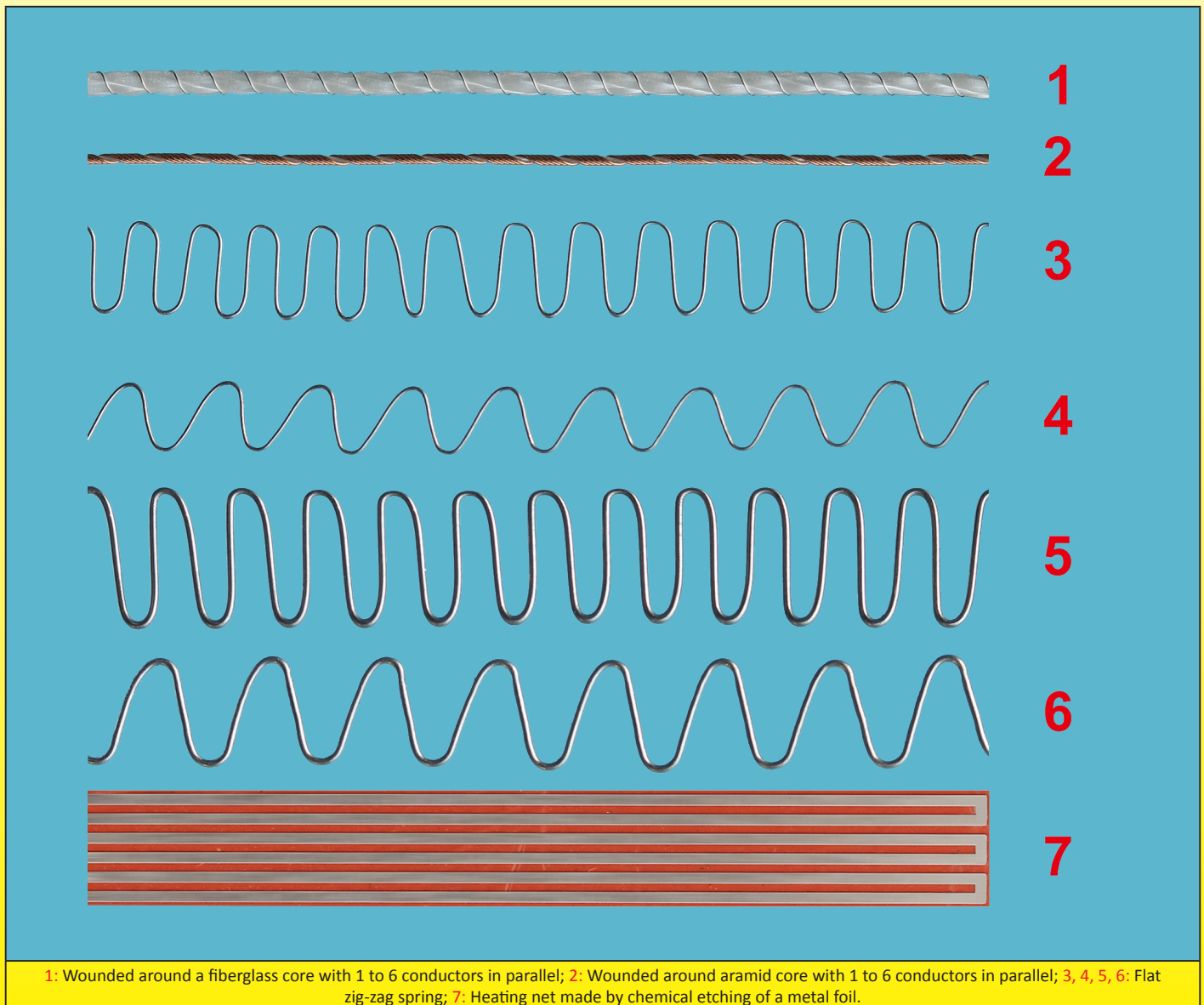

Silicone heaters, technical introduction

5-2. The use of resistive wires with a positive temperature coefficient, null or negative, and consequently, the variation of the power as a function of the temperature.

A little-known parameter of flexible silicone heaters is the variation of their power when the temperature rises. While in the high temperature heaters, manufacturers are looking for heating wires with a coefficient of variation of resistivity in temperature close to zero, and good performance without oxidation at high temperatures, using for example nickel-chromium alloys, in the flexible silicone heaters, the required temperature resistance is lower, as the maximum temperature of use is about 250°C.

This lower maximum temperature makes it possible to use a wider range of metals and alloys, with a range of resistivity values ranging from 0.017 to more than 0.50 Ohms.mm²/m. This very wide resistivity range can be used to build heating elements of almost any surface, while remaining in flexible heating wire diameters. However, all of these alloys and metals have completely different temperature resistivity variation characteristics. It is therefore possible to use this parameter to produce heating elements that will self-regulate (or not) when the temperature rises.

For example, using alloy No. 9 in the table below, a heating element will see its power almost divided by 2 between 20 and 200 °C, while it will remain constant if alloy No. 1 is used.

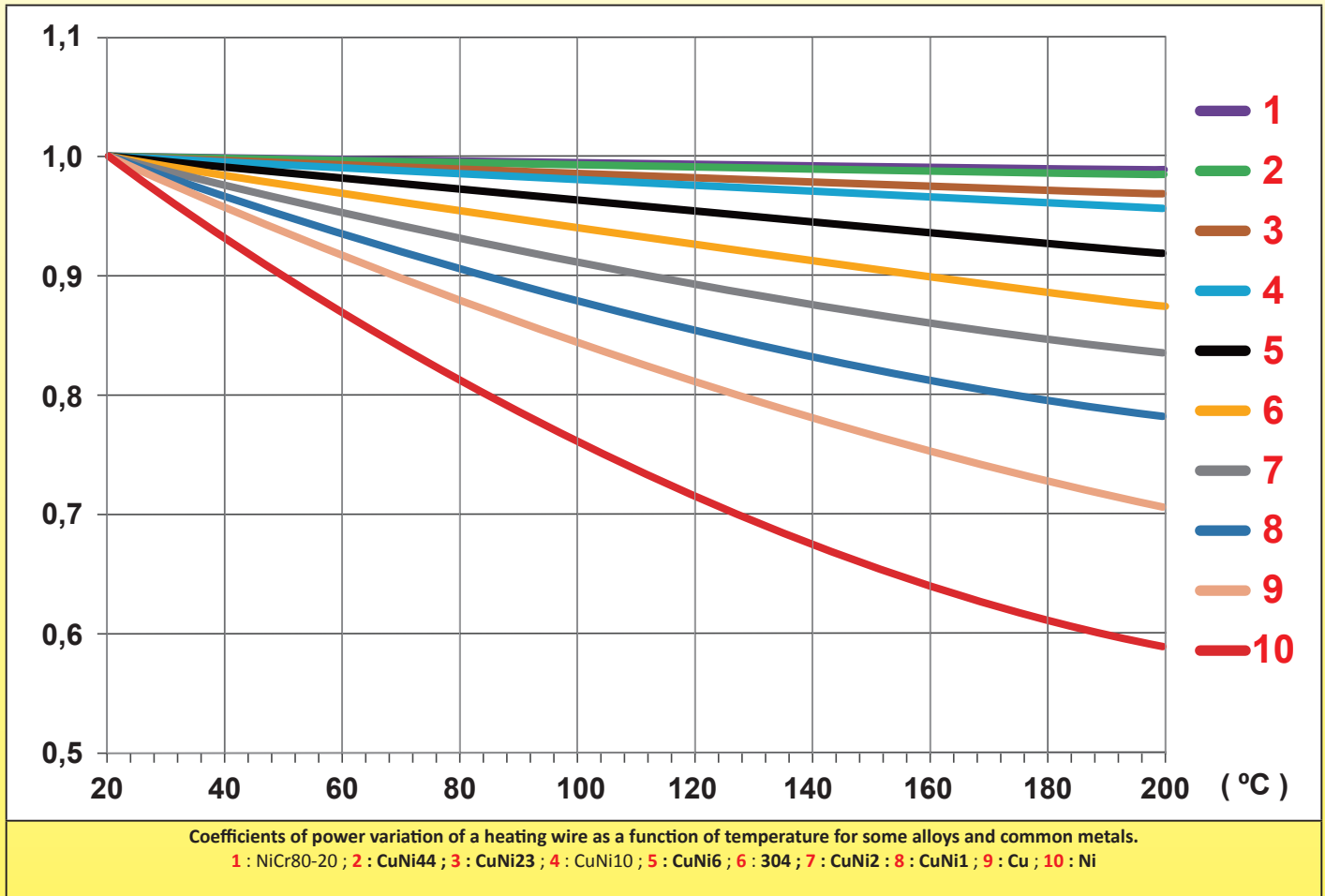

5-3. Design of the reinforced silicone sheets

The most important factor affecting the price of flexible silicone heaters is the weight of silicone per m². Silicone is an expensive raw material, and therefore the development of flexible heaters is based on the minimal use of this material.

The base is a fiberglass net that will be coated on each side with a layer of silicone resin, then polymerized by passing through a heating mill. The total silicone thickness is calculated to provide the electrical insulation (function of the operating voltage), and the fiberglass net to provide the mechanical strength, especially to the elongation. Several layers can be vulcanized together to meet specific applications.

Flexible silicone heaters can be made in 6 main construction configurations:

A- In total thickness of 1.5 to 1.6mm, which corresponds to an insulating thickness of 0.75 to 0.8mm on both sides of the heating conductors. Made with coiled heating wires, it provides the **best resistance to bending**. This solution is **the most economical, especially for small series**, but its mechanical strength is reduced by the small thickness. It is mainly used for heating elements of small surface, or intended to be glued. Having a low mass, it allows a **faster temperature measurement** by thermostats and temperature sensors mounted on its surface.

B- In total thickness of 1.5 to 1.6mm, which corresponds to an insulation thickness of 0.75 to 0.8mm on both sides of a

Because of permanent improvement of our products, drawings, descriptions, features used on these data sheets are for guidance only and can be modified without prior advice



Silicone heaters, technical introduction

heating network produced by **chemical etching**. This solution is the most economical for the **production of large series**, but the **least resistant to bending**. Having the lowest mass, the best heat distribution, it allows a **faster temperature measurement** of thermostats and temperature sensors mounted on its surface.

C- In total thickness from 2 to 2.2mm, which corresponds to an insulation thickness of 1 to 1.1mm on both sides of the heating conductors. This solution **improves** the electrical insulation towards the outside of the heating part because the **use of heating conductors with a primary insulation in FEP** confers the insulation class 2 to this assembly, without increasing its thickness too much. This solution is used in heating appliances subject to a regulation requiring an insulation class 2.

D- In total thickness of 2.4 to 2.5mm, which corresponds to an insulation thickness of 0.75 to 0.8mm on one side and 1.6mm on the other of the heating conductors. **This solution improves the mechanical resistance** and the electrical insulation towards the outside of the heating part. It is used for heating belts to be mounted and disassembled frequently, and large surface elements subjected to mechanical stresses

E- In total thickness of 2.5 to 2.6mm, which corresponds to an insulation thickness of 0.75 to 0.8mm on one side and 1.6mm on the other side of the heating conductors. In this thickness of 1.6mm is sandwiched a **fine wire mesh** of protection against punching and which also **allows an efficient grounding**. This solution improves electrical protection and resistance to elongation, but **reduces flexibility**.

A variant of this solution consists of using heating conductors comprising a primary electrical insulation covered with a metal braid.

F- In total thickness of 3.2 to 3.4 mm, which corresponds to an insulation thickness of 1.6 mm on both sides of the heating conductors. This solution provides the highest mechanical strength and **double insulation heaters** (Class 2), but this extra thickness between the heating conductors and the surface increases the heat transfer time and therefore the **risk of overheating**.

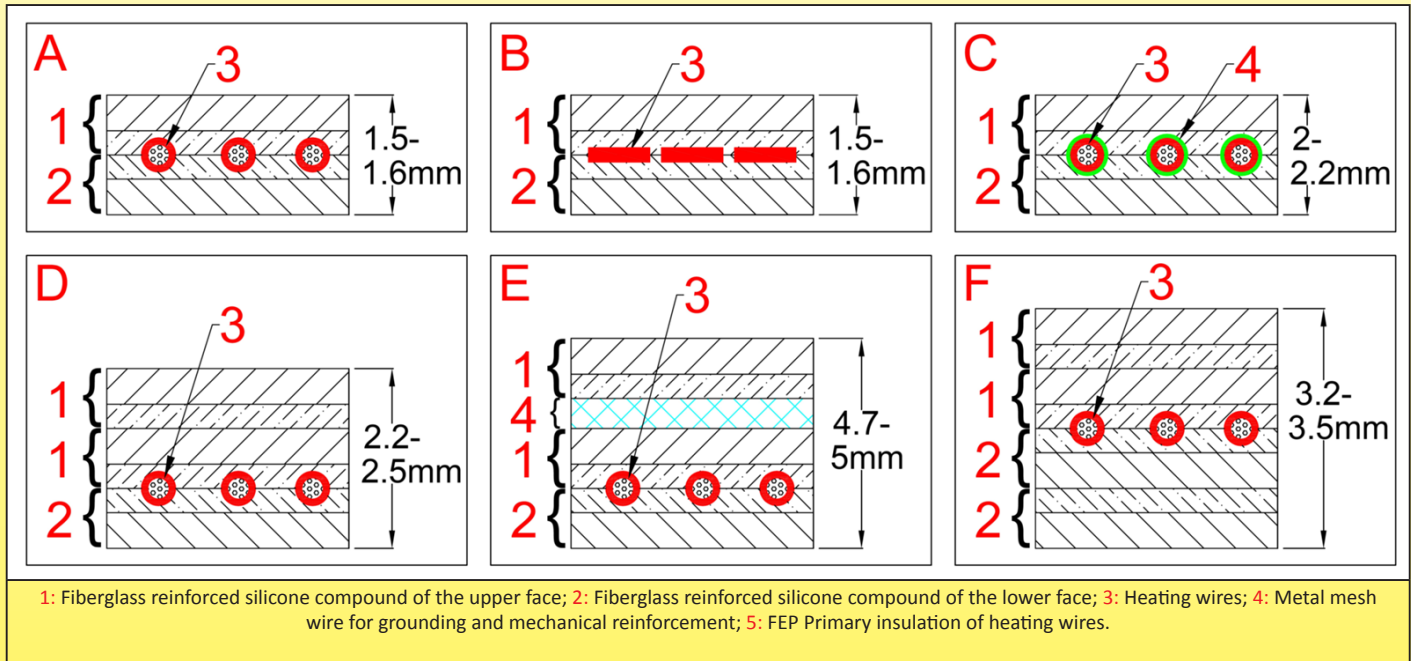

5-4. Flexible silicone heaters surface coating

The flexible elements can receive equipment that is assembled on their surface, in order to meet different applications.

The main combinations are:

A: No equipment

B: One side with bonded or vulcanized silicone insulating foam, providing thermal insulation to the outside

C: One side with PSA type adhesive, usually of acrylic type, very thin, to stick the heating element on the wall to be heated. Adhesives can be used up to 200°C.

D: One side with PSA type adhesive, generally of acrylic type, very thin, for gluing the heating element to the wall to be heated, the opposite side being equipped with a bonded or vulcanized silicone insulating foam, providing thermal insulation towards the outside.

E: Heating element glued to a heat conductive metal plate. This solution provides a good temperature homogeneity of the surface and allows to reach higher surface loads.

F: Heating element glued to a heat conductive metal plate. This solution provides a good temperature homogeneity of the surface and allows to reach higher surface loads. The outer face of the resistor receives a thermal insulating silicone foam, improving the heating efficiency.



Silicone heaters, technical introduction

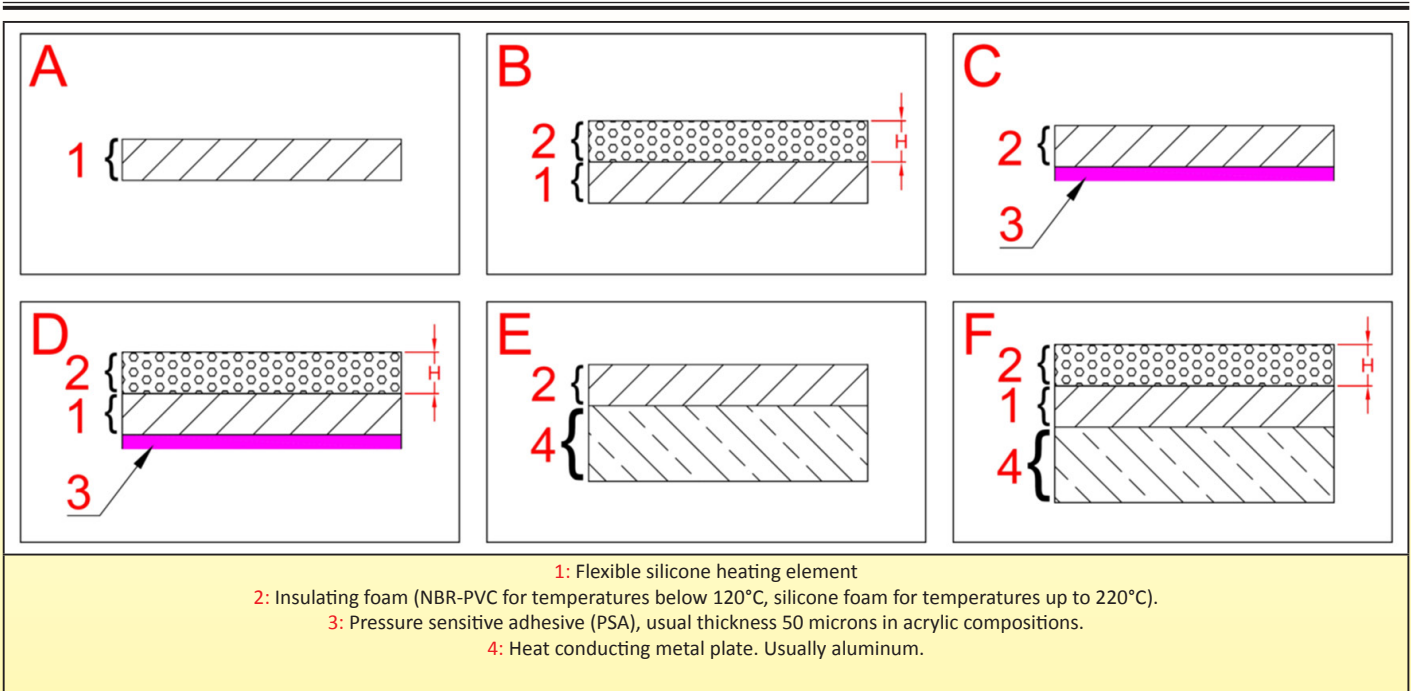

5-5. Mechanical strength of flexible silicone heaters

Silicone heaters are often subject to mechanical stress during installation or during use. To withstand these constraints technical solutions and validation tests are required.

The main constraints of their industrial applications are in particular:

- 1- The resistance to tearing, critical when heating elements are fixed by holes made in their thickness, for example to place screws, cords, rivets, or when asperities exist on the surface
- 2- The creep resistance, critical when the heating elements are permanently stretched by springs on a cylindrical tank, for example in heating belts.
- 3- Resistance to tearing of spring mounting hooks on heating belts
- 4- The pull-out resistance of electric power cables and wires, the minimum values of which are given by the electrical standards.
- 5- The resistance to separation of the various vulcanized layers, a critical parameter for the proper functioning of these heating elements.
- 6- Bending resistance, which makes it possible to verify that the heating elements can be placed on cylindrical walls, a critical parameter of heating belts and ribbons for electrical tracing.
- 7- The resistance to tearing of the silicone protective boxes of thermostats, limiters, temperature sensors, which must ensure that the safety or temperature control systems retain its function, therefore detaching them from the heating surface must not happen.

All these constraints have been the subject of validation tests before the devices are put into circulation on the market.

Tear strength

This tear strength test is made on the different thicknesses of the versions A(1.5/1.6mm), B (2.2/2.5mm), C (2.3/2.6mm) and D (3.2/3.5mm), on laser cut specimens with dimensions in accordance with EN 60335-2-17§21.110.1.

This test allows to check the quality of weaving used in the fiberglass reinforcement.



Silicone heaters, technical introduction

Because of permanent improvement of our products, drawings, descriptions, features used on these data sheets are for guidance only and can be modified without prior advice

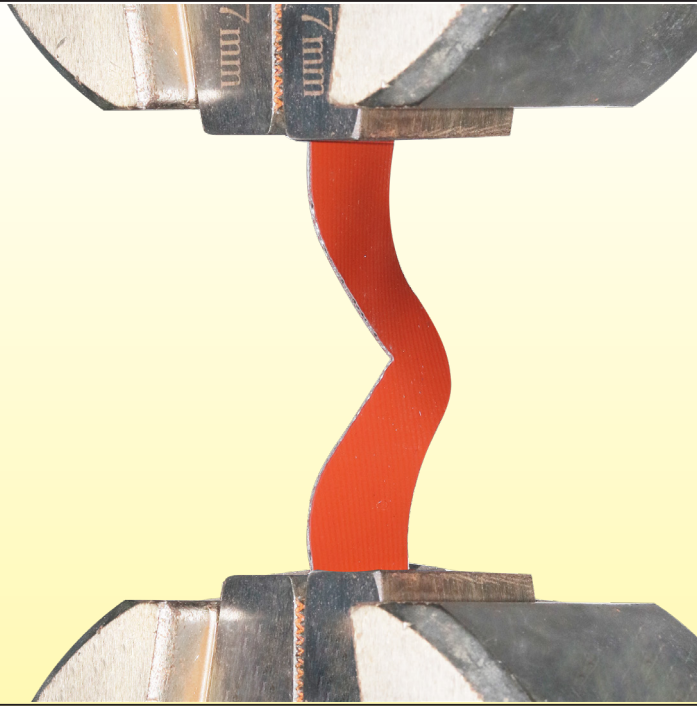

Sample used for testing



Tear strength testing equipment

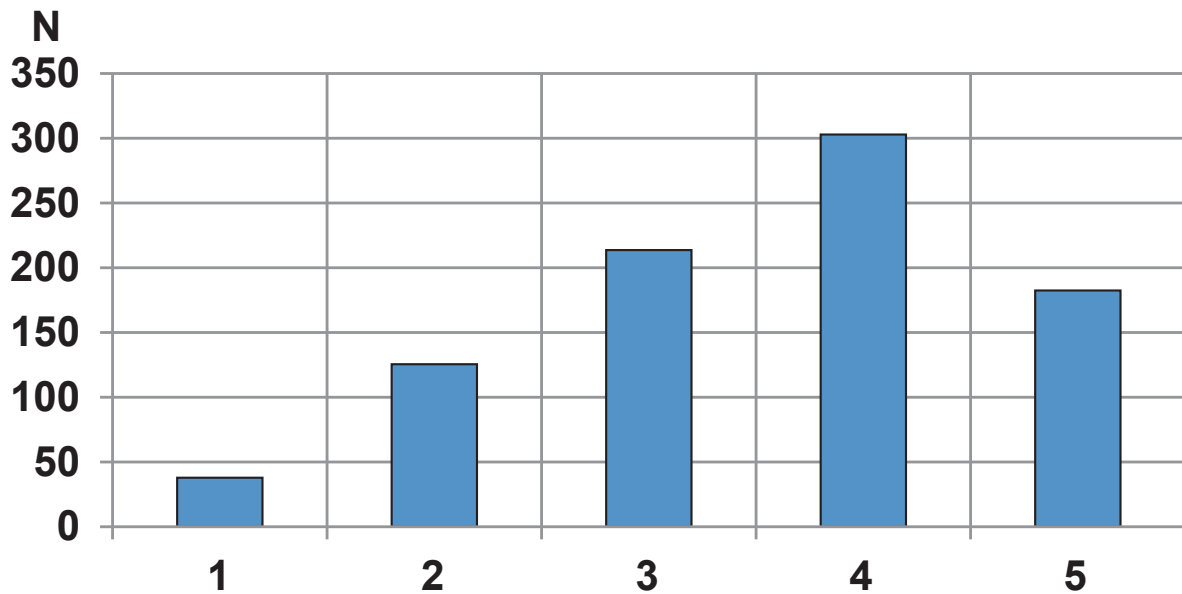

Comparative tear strength of the different thicknesses models
1 : 0.8mm ; 2 : 1.6mm ; 3 : 2.3mm ; 4 : 3.2mm ; 5 : 2.3mm with stainless steel mesh reinforcement

Creeping

In applications in which a permanent stress is applied, an elongation of the flexible silicone resistances may result in loosening and causing a gap with the heated surface. The resulting change in heat exchange can produce overheating. We therefore measured the force required to elongate 1.5mm in 30 minutes over a typical 300mm long heater in the different thickness configurations. (version with 1.6mm thickness is the reference basis).

This test allowed us to select the less creeping sensible fiberglass reinforced silicone sheets. The tests show that the creep is almost independent of the number of layers of glass fiber reinforced silicone, but above all depends on the quality of the bonding between the silicone resin and the fiberglass frame.



Silicone heaters, technical introduction

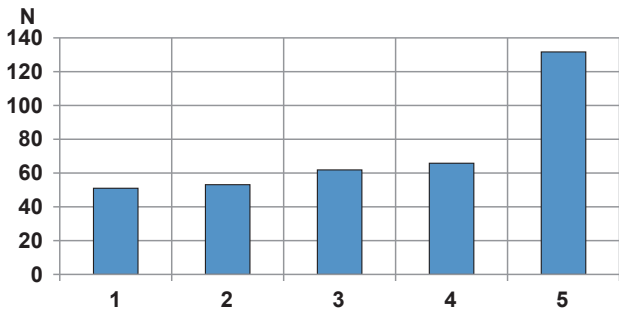

Comparative elongation strength at 0.05mm/min of the different thicknesses models 1 : 0.8mm, 2 : 1.6mm, 3 : 2.4mm ; 4 : 3.2mm 5 : 2.4mm with stainless steel mesh reinforcement

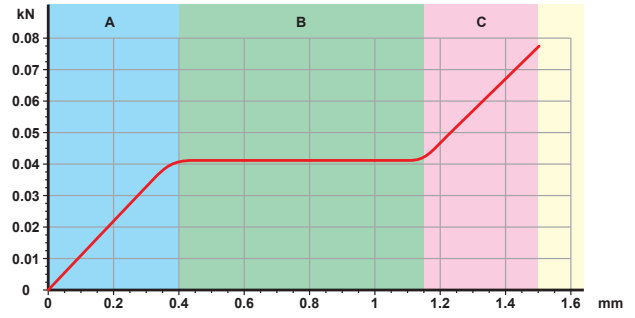

Creep curve type of a sheet of reinforced silicone fiberglass. In section A, the elongation is proportional to the applied force. In this section, the silicone is lengthened by opposing a resistance proportional to its elasticity. In section B, the elongation occurs without increasing the tensile force: this is due to the deformation of the fiberglass braiding meshes that separate from the silicone. In section C: the mesh of the weft can no longer be deformed, and the tension is applied directly on the fiberglass threads which will gradually break.



Type of sample tested (350 x 35mm)



Sample during testing

Holding hooks resistance to tearing

The tearing of a hook used to tension the heating belts will cause its falling from the barrel on which it is installed, and consequently the overheating and the immediate destruction of the belt, which may be the cause of a fire. Thanks to the technology used, the force required to pull the hook supports off the heating belt **is at least 50% greater than the force required to deform and straighten the metal hooks**



Tear force testing sample

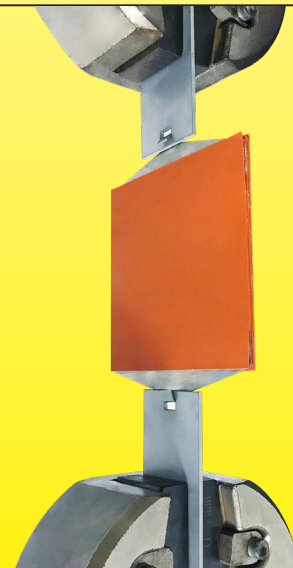

Tear force testing equipment

Because of permanent improvement of our products, drawings, descriptions, features used on these data sheets are for guidance only and can be modified without prior advice



Silicone heaters, technical introduction

Split resistance of the vulcanized layers

One of the critical and **invisible** defects of flexible silicone heaters is incomplete vulcanization of the layers between which the heating wire is inserted. This incomplete vulcanization may be due to insufficient pressure, insufficient temperature, too short a compression time, a poorly dosed silicone resin or whose shelf life is exceeded. This defect will cause the uncoupling of the layers, the formation of bubbles, and the premature destruction of the heating wire. It is therefore important to be able to quantify this adhesion in order to optimize the vulcanization parameters. This test makes it possible in particular to measure the aging of semi-vulcanized silicone resins, since their storage time is limited. It also allows to check the constancy of the vulcanization over a long length.



Vulcanized sample before decoupling test

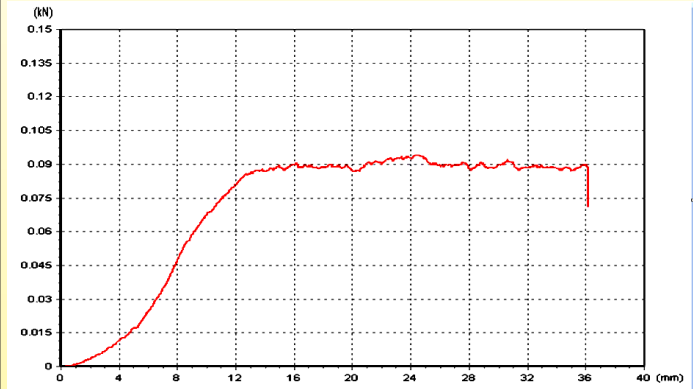

Curve of the decoupling force on a displacement of some cm. It can be noted that when the vulcanization quality is good (as shown in this chart), the decoupling force is constant, with an average separating force of 9 DaN for 10cm bandwidth.

Flexing resistance

In flexible heaters, flexural strength is a parameter used to check if heating wires are correctly formed and embedded inside the fiberglass reinforced silicone sheets. This test, made in a special equipment, makes it possible to verify that a fold in the heating element according to a precise radius will not result in a mechanical stress of the conductor which would provoke its breaking immediately or eventually after some folding.

It is based on UL817 and EN60335-1-25 specifications.

This test consists of an alternating flexion at 60 cycles per minute, bending at 90° (45° on each side of the vertical) on a 5mm radius. A load of 100 gr. per 100 mm width is added to the free end of the heating element. Criterion of acceptance: 500 cycles without heating wire breakage or change of more than 1% of its electrical resistance.



Flexible silicone heater during the flexion test

Because of permanent improvement of our products, drawings, descriptions, features used on these data sheets are for guidance only and can be modified without prior advice



Silicone heaters, technical introduction

Tear strength of silicone protective housings of thermostats, limiters, temperature sensors.

All boots and protective boxes are vulcanized on the silicone sheets. These components are made of semi-flexible silicone with a hardness of 70 Shore A, having a flange with a large contact surface for vulcanization. As a result, their tear resistance is about **10 times** greater than traditional glued models. In some models, after vulcanization, an additional filling, is made with heat-conductive RTV resin to provide protection against water penetration and / or better heat exchange with the surface of the heating element.

Comparison of the different vulcanization techniques and adhesives used for the bonding of silicone caps on flexible silicone heating surfaces.

These tests are carried out with a particular test boot allowing to have reproducible results.

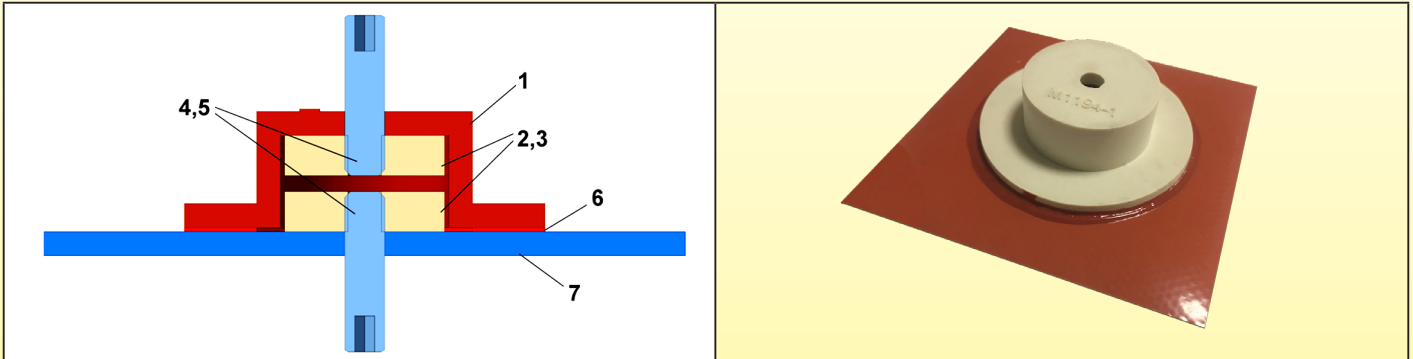

Equipment used for comparative tests (Bonding surface: 10 cm²).

- 1: 70 Shore A silicone test cap;
- 2, 3: Inner washers;
- 4, 5: Traction screws;
- 6: Adhesive tested, vulcanized or polymerized;
- 7: Silicone heating element of 10 x 10 cm.

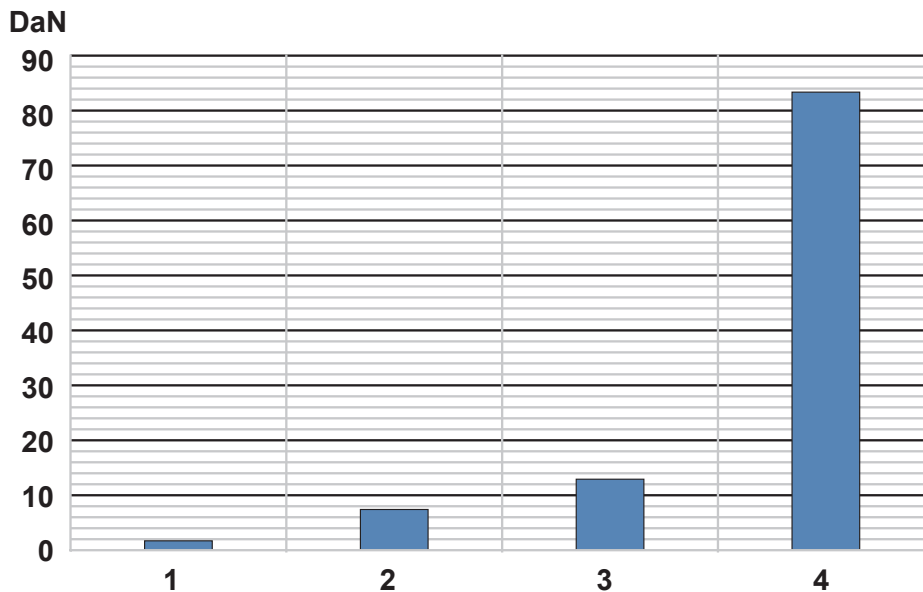

Comparative tear values

- 1/- Boot vulcanised at 180°C with two-component silicone adhesive: Average value 1.9DaN
- 2/- Boot glued with a high temperature single component silicone resin (RTV) polymerizing at room temperature: Average value 7.6DaN
- 3/- Boot glued with a high temperature single component high strength silicone resin (RTV) polymerizing at room temperature: Average value 13DaN.
- 4/- Boot vulcanised at medium temperature with silicone resin used in our production: Average value 84DaN. This represent 8.4DaN tear strength by cm² of bonded surface.

5-6. Connection methods for wires, cables, temperature sensors and thermostats

Two types of power lead connections are used in flexible silicone heaters:

- The connection by independent wires (one for each phase), intended for the heaters whose incorporation in an apparatus is carried out by the manufacturer of this apparatus. The gauge of conductors is determined by the power of the heating element. In this version, the mechanical resistance to tearing is achieved by a vulcanized patch.
- The connection by a cable, with two or three conductors, usually equipped with a plug, for devices intended for an end user. In this case the mechanical resistance to tearing is achieved by a vulcanized silicone boot, and possibly a locking system of the cable by mechanical clamping. Under the most critical operating conditions the vulcanized boot can be riveted to the heating element.

Silicone heaters, technical introduction

The tearing values to which cables and wires are subjected comply with the specifications of EN60335-1-25.12:

- 3 DaN for heating elements with a mass of less than 1 kg,
- 6 DaN for those with a mass of 1 to 4 kg,
- 10 DaN for those over 4 kg.

These constraints determine the design and characteristics of the patches and caps used

Connection of wires on flexible silicone heaters (IP54)

This connection, the most common on small dimensions flexible heaters, is made by a silicone patch vulcanized on the solder between the power supply conductors and the heating wires. It provides mechanical support and a relative ingress protection (IP54).

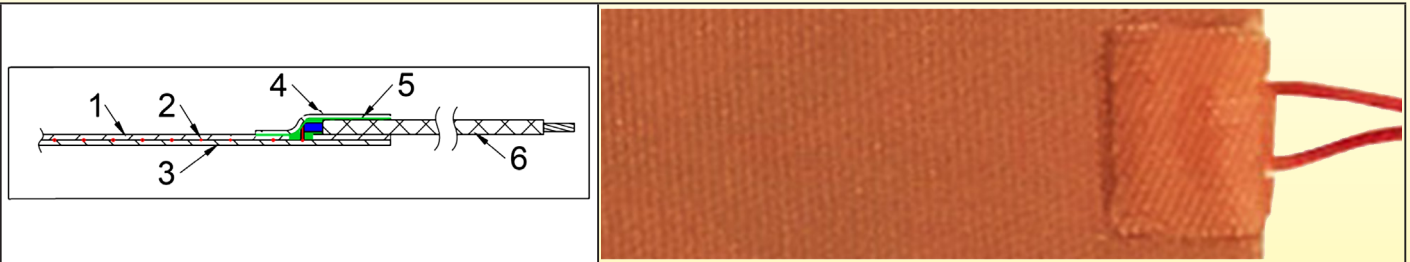

- 1: Fiberglass reinforced silicone sheet (Upper side).
- 2: Heating wire.
- 3: Fiberglass reinforced silicone sheet (Lower side).
- 4: Wire outlet fiberglass reinforced silicone patch
- 5: Vulcanized silicone resin (in green) fixing the patch on the silicone upper sheet and on the wires.
- 6: Power supply wires.

Connection of cables on flexible silicone heaters (IP65)

These caps allow the connection of 3 conductors round cables. They allow to connect the earth of the power cord to an internal terminal, useful to connect the flexible resistances with a metal grid. An external screw terminal is also grounded, for the connection of metal parts of tanks or heated walls. The filling of the boot with a silicone resin makes the assembly extremely resistant to tearing off and guarantees an IP65 degree of water and dust ingress.

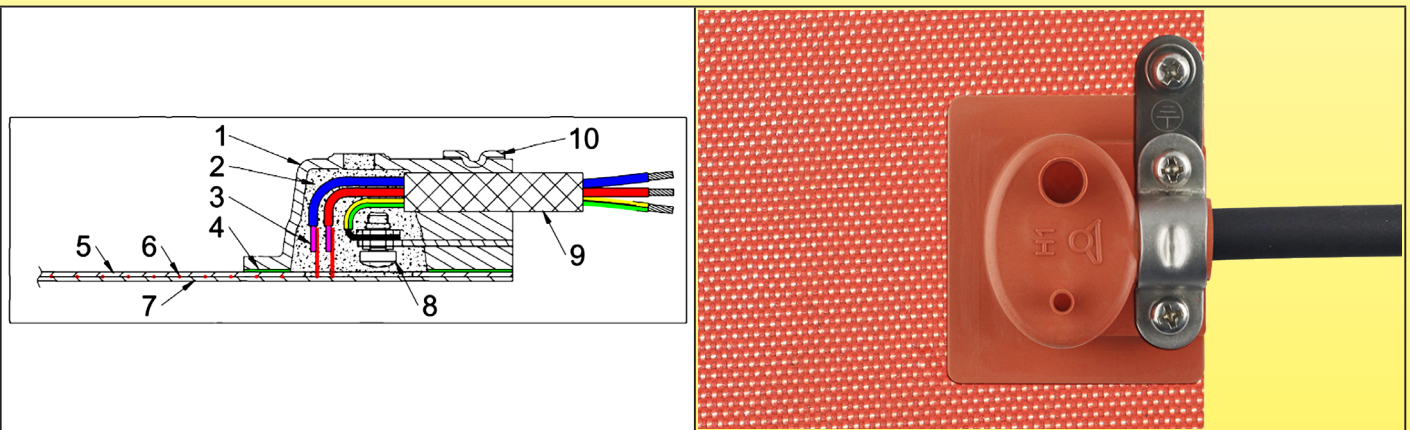

- 1: Protection boot
- 2: Silicone resin filling
- 3: Power supply wires
- 4: Vulcanized resin fixing the boot on the silicone heater
- 5: Fiberglass reinforced silicone sheet (Upper side)
- 6: Heating wire
- 7: Fiberglass reinforced silicone sheet (Lower side)
- 8: Ground terminal
- 9: 3-conductor power supply cable
- 10: Stainless steel clamp for power supply cable

Connection of cables and temperature limiters on flexible silicone heaters (IP65)

These caps allow the connection of 3 conductors round cables. They allow first to connect the earth of the power cord to an internal terminal, useful to connect the flexible resistances with a metal grid. An external screw terminal is also grounded, for the connection of metal parts of tanks or heated walls.

Secondly, they allow to connect a fixe setting bimetal temperature limiter in serial with the heating element. The filling of the boot with a silicone resin makes the assembly extremely resistant to tearing off and guarantees an IP65 degree of water and dust ingress.

Because of permanent improvement of our products, drawings, descriptions, features used on these data sheets are for guidance only and can be modified without prior advice



Silicone heaters, technical introduction

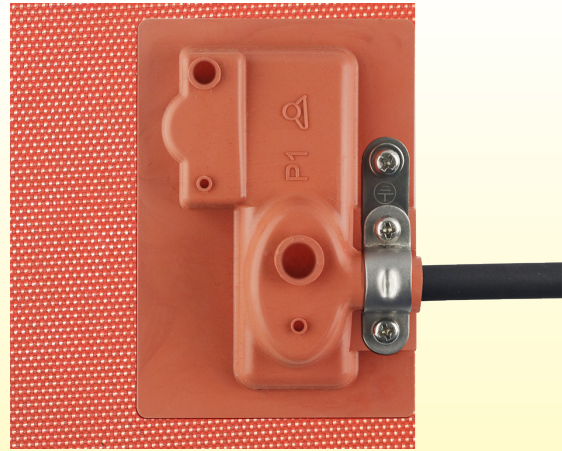
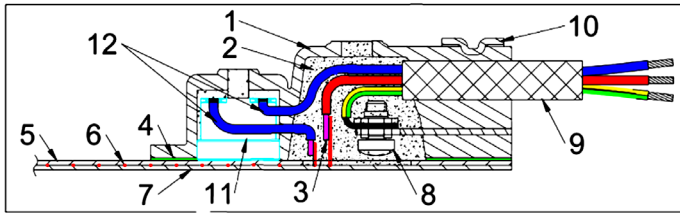

- 1: Protection boot
- 2: Silicone resin filling
- 3: Power supply wires
- 4: Vulcanized resin fixing the boot on the silicone heater
- 5: Fiberglass reinforced silicone sheet (Upper side)
- 6: Heating wire
- 7: Fiberglass reinforced silicone sheet (Lower side)
- 8: Ground terminal
- 9: 3-conductor power supply cable
- 10: Stainless steel clamp for power supply cable
- 11: Fixed setting bimetal thermostat
- 12: Bimetal thermostat connection wires

Connection of cable and temperature sensor on flexible silicone heaters (IP65)

These caps allow the connection of 5 conductors round cables. Firstly, they allow to connect the earth of the power cord to an internal terminal, useful to connect the flexible resistances with a metal grid. An external screw terminal is also grounded, for the connection of metal parts of tanks or heated walls.

Secondly, they allow to connect a 2 wires temperature sensor (2 wires Pt100, NTC or thermocouple). The filling of the boot with a silicone resin makes the assembly extremely resistant to tearing off and guarantees an IP65 degree of water and dust ingress.

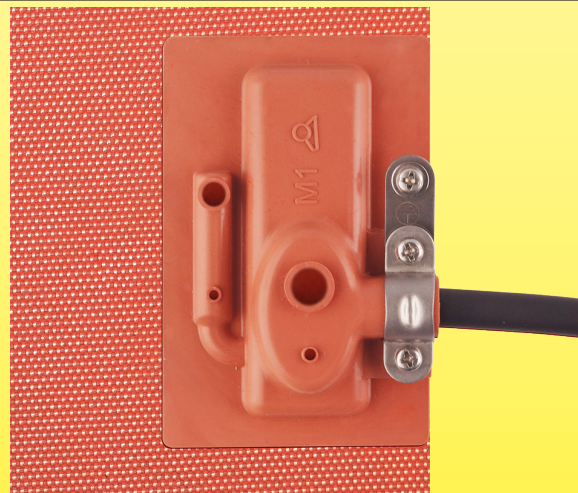
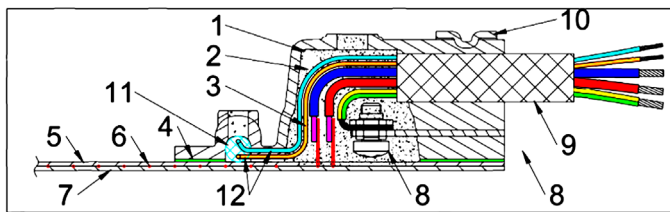

- 1: Protection boot
- 2: Silicone resin filling
- 3: Power supply wires
- 4: Vulcanized resin fixing the boot on the silicone heater
- 5: Fiberglass reinforced silicone sheet (Upper side)
- 6: Heating wire
- 7: Fiberglass reinforced silicone sheet (Lower side)
- 8: Ground terminal
- 9: 3-conductor power supply cable
- 10: Stainless steel clamp for power supply cable
- 11: Temperature sensor
- 12: Temperature sensor connection wires

Because of permanent improvement of our products, drawings, descriptions, features used on these data sheets are for guidance only and can be modified without prior advice



Silicone heaters, technical introduction

Connection of cable and adjustable bimetal thermostat on flexible silicone heaters (IP54)

These flexible enclosures allow the connection of 3 conductors round cables. Firstly, they allow to connect the earth of the power cord to an internal terminal, useful to connect the flexible resistances with a metal grid. An external screw terminal is also grounded, for the connection of metal parts of tanks or heated walls.

Secondly, they allow to connect an adjustable bimetal thermostat measuring the temperature of the silicone heater surface on which it is in contact. The large bonding surfaces of the enclosure make the assembly extremely resistant to tearing off. This enclosure guarantees an IP54 degree of water and dust ingress protection.

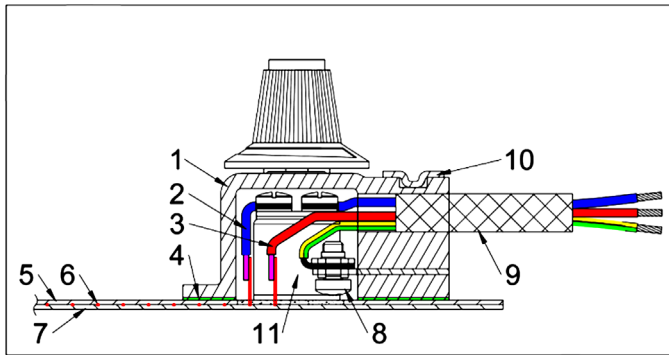

- 1: Flexible and reinforced protection enclosure
- 2: Wire connecting the thermostat to the heating element
- 3: Silicon foam sheet providing thermal insulation between thermostat body and heating element.
- 4: Vulcanized resin fixing the boot on the silicone heater
- 5: Fiberglass reinforced silicone sheet (Upper side)
- 6: Heating wire
- 7: Fiberglass reinforced silicone sheet (Lower side)
- 8: Ground terminal
- 9: 3-conductor power supply cable
- 10: Stainless steel clamp for power supply cable
- 11: Thermostat body

Connection of cable and adjustable bulb and capillary thermostat on flexible silicone heaters (IP54)

These flexible enclosures allow the connection of 3 conductors round cables. Firstly, they allow to connect the earth of the power cord to an internal terminal, useful to connect the flexible resistances with a metal grid. An external screw terminal is also grounded, for the connection of metal parts of tanks or heated walls.

Secondly, they allow to connect an adjustable bulb and capillary thermostat. The silicone foam sheet protect the thermostat body from the heating surface temperature. The large bonding surfaces of the enclosure make the assembly extremely resistant to tearing off. This enclosure guarantees an IP54 degree of water and dust ingress protection.

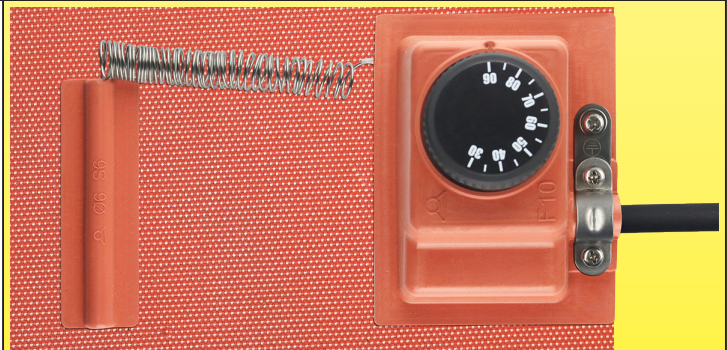
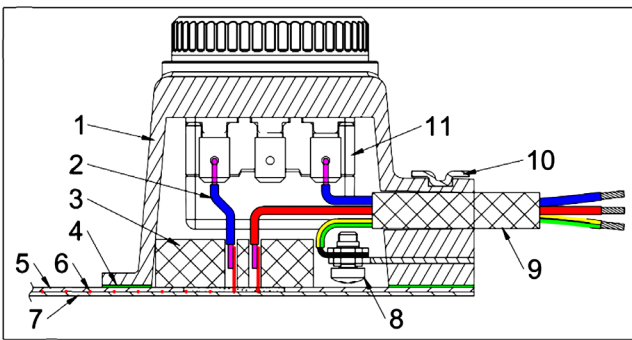

- 1: Flexible and reinforced protection enclosure
- 2: Wire connecting the thermostat to the heating element
- 3: Silicon foam sheet providing thermal insulation between thermostat body and heating element.
- 4: Vulcanized resin fixing the boot on the silicone heater
- 5: Fiberglass reinforced silicone sheet (Upper side)
- 6: Heating wire
- 7: Fiberglass reinforced silicone sheet (Lower side)
- 8: Ground terminal
- 9: 3-conductor power supply cable
- 10: Stainless steel clamp for power supply cable
- 11: Thermostat body



Silicone heaters, technical introduction

5-7. Parameters of electrical insulation of flexible silicone heaters

Insulation resistance at ambient temperature

The insulation resistance decreases with the length of heating wire used. If this length can go down to a few meters in the small silicone heaters, it can exceed more than 250 meters on the large models. In production, the insulation values are 100% measured at ambient temperature. Our minimum acceptance limit is 0.1Gohms (100x the limit of EN60335-2-17§ 19.112.3).

This measurement is carried out with the heater sandwiched between two metal sheets covering the entire surface and pressed against each other with a load of 35 DaN/m².

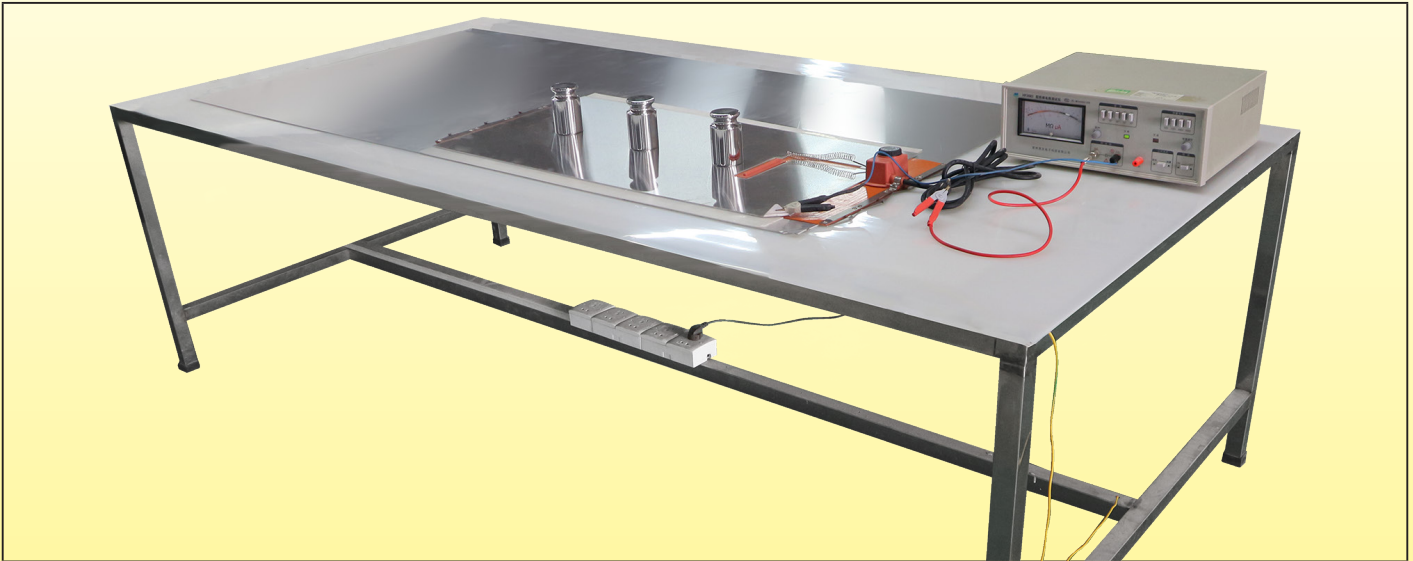

Device for measuring the insulation resistance.
The measured values are always greater than 0.1Gohm

Electric strength at ambient temperature

In all protected heating elements, there is a leakage current passing through their insulation. This leakage current increases with the applied voltage.

In the case of silicone heaters, a production test for measuring the **total leakage current** is performed by placing the heater between two metal plates and applying a voltage of 1750 volts between the conductors and the metal plates according to 60-335-2 -17 § 22.115. In application of the EN60519-1 standard, the maximum leakage current allowed during **1 minute** is a function of the nominal ampacity of the heater, it is 3mA for ampacities less than 7A (1600W in 230V) and 0.5mA per ampere for higher currents (eg 10mA for 2000W, 15mA for 3000W). The large value of the leakage current on the large dimensions heaters requires their connection to a power supply circuit protected by a differential circuit breaker calibrated at 20mA.



Measuring equipment for total current leakage at cold condition

Because of permanent improvement of our products, drawings, descriptions, features used on these data sheets are for guidance only and can be modified without prior advice

Silicone heaters, technical introduction

Leakage current at working temperature

Leakage current measurement on hot and accessible surfaces is a parameter intended to verify the safety of an appliance to avoid electric shock when touched while it is in operation. **This is a way to check that its electrical insulation does not degrade and remains sufficient when the operating temperature is reached.** The tests consist, in accordance with the articles of standards EN60335-1-13.1 and 13.2, to place a metal plate of 10 x 20 cm (simulating the size of a hand) on the heater, and to measure the current passing between this plate and the live conductors when the silicone heater has reached its maximum temperature, which can rise up to 200°C on some models. The maximum limit value is 0.75mA at 240V. Our tests are validated by an average value of 6 measurements made at different locations, under a power equal to 1.15 times the nominal power.

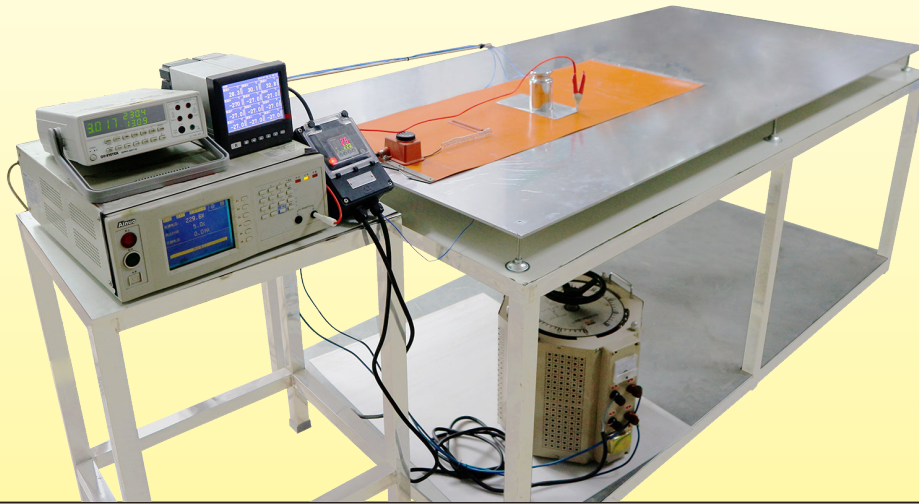

Measuring equipment for total current leakage at hot condition

5-8. Rohs and Reach compliance

Rohs: The materials used in the flexible silicone heaters comply with the European directive 2015/863 Annex II amending Directive 2011/65.

These tests are part of the standard quality control at Ultimheat, and are performed systematically for the validation of each supplier's delivery.

They are made in our own laboratory, with latest-generation measuring instruments.

If desired, we can provide certificates made by an approved external laboratory.

Reach: The materials used in the flexible silicone heaters comply with the REACH European Directives according to the June 2017 directive adding 173 substances SVHC (Substances of Very High Concern) from the list published by ECHA on 12 January 2017, applying to the Reach directive 1907/2006.

Certificates made by an accredited external laboratory available on request.

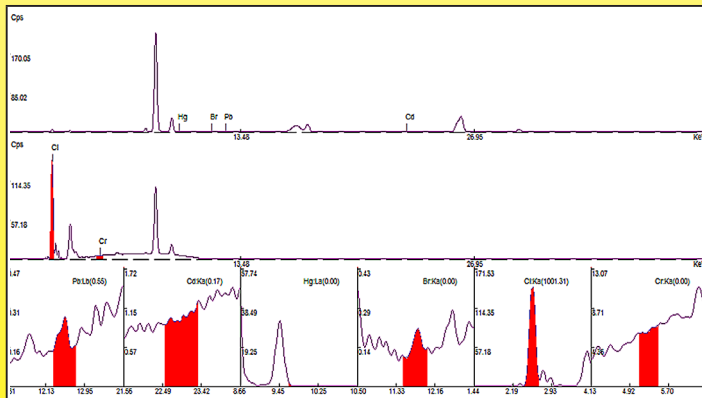

Rohs spectrogram of a fiberglass reinforced silicone sheet (Ultimheat laboratory)



Spectrometric analysis in progress (Ultimheat Laboratory)

Because of permanent improvement of our products, drawings, descriptions, features used on these data sheets are for guidance only and can be modified without prior advice



Silicone heaters, technical introduction

Because of permanent improvement of our products, drawings, descriptions, features used on these data sheets are for guidance only and can be modified without prior advice



References list





References list

Because of permanent improvement of our products, drawings, descriptions, features used on these data sheets are for guidance only and can be modified without prior advice

References list
9ASA2011B5804U30
9ASA3011B5807U30
9ASA4011B5809U30
9ASA5011B5811U30
9ASA6011B5813U30
9ASA7011B5816U30
9ASA8011B5818U30
9ASF2011B5804U30
9ASF3011B5807U30
9ASF4011B5809U30
9ASF5011B5811U30
9ASF6011B5813U30
9ASF7011B5816U30
9ASF8011B5818U30
9ASA2K11B5804U30
9ASA3K11B5807U30
9ASA4K11B5809U30
9ASA5K11B5811U30
9ASA6K11B5813U30
9ASA7K11B5816U30
9ASA8K11B5818U30
9ASF2K11B5804U30
9ASF3K11B5807U30
9ASF4K11B5809U30
9ASF5K11B5811U30
9ASF6K11B5813U30
9ASF7K11B5816U30
9ASF8K11B5818U30
9ASA1011E0804U30
9ASA2021E0809U30
9ASA3021E0813U30
9ASA4021E0818U30
9ASA5013E0822U30
9ASA6013E0827U30
9ASA7015E0831U30
9ASA8026E0818U30
9ASF1011E0804U30
9ASF2021E0809U30
9ASF3021E0813U30
9ASF4021E0818U30
9ASF5013E0822U30
9ASF6013E0827U30
9ASF7015E0831U30
9ASF8026E0818U30
9ASA1K11E0804U30
9ASA2K21E0809U30
9ASA3K21E0813U30
9ASA4K21E0818U30
9ASA5K13E0822U30
9ASA6K13E0827U30
9ASA7K15E0831U30
9ASA8K26E0818U30
9ASF1K11E0804U30
9ASF2K21E0809U30
9ASF3K21E0813U30
9ASF4K21E0818U30
9ASF5K13E0822U30
9ASF6K13E0827U30
9ASF7K15E0831U30
9ASF8K26E0818U30
9ASA1021J0809U30
9ASA2022J0818U30

References list
9ASA3023J0818U30
9ASA4025J0836U30
9ASA5025J0845U30
9ASA6025J0854U30
9ASA7025J0863U30
9ASA8025J0872U30
9ASF1021J0809U30
9ASF2022J0818U30
9ASF3023J0818U30
9ASF4025J0836U30
9ASF5025J0845U30
9ASF6025J0854U30
9ASF7025J0863U30
9ASF8025J0872U30
9ASA1K21J0809U30
9ASA2K22J0818U30
9ASA3K23J0818U30
9ASA4K25J0836U30
9ASA5K25J0845U30
9ASA6K25J0854U30
9ASA7K25J0863U30
9ASA8K25J0872U30
9ASF1K21J0809U30
9ASF2K22J0818U30
9ASF3K23J0818U30
9ASF4K25J0836U30
9ASF5K25J0845U30
9ASF6K25J0854U30
9ASF7K25J0863U30
9ASF8K25J0872U30
9ASA4061B5809U30
9ASA5061B5811U30
9ASA6061B5813U30
9ASA7061B5816U30
9ASA8061B5818U30
9ASF4061B5809U30
9ASF5061B5811U30
9ASF6061B5813U30
9ASF7061B5816U30
9ASF8061B5818U30
9ASA4K61B5809U30
9ASA5K61B5811U30
9ASA6K61B5813U30
9ASA7K61B5816U30
9ASA8K61B5818U30
9ASF4K61B5809U30
9ASF5K61B5811U30
9ASF6K61B5813U30
9ASF7K61B5816U30
9ASF8K61B5818U30
9ASA4064E0822U30
9ASA7064E0831U30
9ASA8064E0836U30
9ASF4061E0804U30
9ASF4062E0809U30
9ASF4063E0813U30
9ASF4064E0818U30
9ASF4065E0822U30
9ASF4066E0827U30
9ASF4067E0831U30
9ASF4068E0836U30
9ASF4069E0845U30
9ASF4070E0854U30
9ASF4071E0863U30
9ASF4072E0872U30
9ASF4073E0881U30
9ASF4074E0890U30
9ASF4075E0899U30
9ASF4076E0908U30
9ASF4077E0917U30
9ASF4078E0926U30
9ASF4079E0935U30
9ASF4080E0944U30
9ASF4081E0953U30
9ASF4082E0962U30
9ASF4083E0971U30
9ASF4084E0980U30
9ASF4085E0989U30
9ASF4086E0998U30
9ASF4087E1007U30
9ASF4088E1016U30
9ASF4089E1025U30
9ASF4090E1034U30
9ASF4091E1043U30
9ASF4092E1052U30
9ASF4093E1061U30
9ASF4094E1070U30
9ASF4095E1079U30
9ASF4096E1088U30
9ASF4097E1097U30
9ASF4098E1106U30
9ASF4099E1115U30
9ASF4100E1124U30
9ASF4101E1133U30
9ASF4102E1142U30
9ASF4103E1151U30
9ASF4104E1160U30
9ASF4105E1169U30
9ASF4106E1178U30
9ASF4107E1187U30
9ASF4108E1196U30
9ASF4109E1205U30
9ASF4110E1214U30
9ASF4111E1223U30
9ASF4112E1232U30
9ASF4113E1241U30
9ASF4114E1250U30
9ASF4115E1259U30
9ASF4116E1268U30
9ASF4117E1277U30
9ASF4118E1286U30
9ASF4119E1295U30
9ASF4120E1304U30
9ASF4121E1313U30
9ASF4122E1322U30
9ASF4123E1331U30
9ASF4124E1340U30
9ASF4125E1349U30
9ASF4126E1358U30
9ASF4127E1367U30
9ASF4128E1376U30
9ASF4129E1385U30
9ASF4130E1394U30
9ASF4131E1403U30
9ASF4132E1412U30
9ASF4133E1421U30
9ASF4134E1430U30
9ASF4135E1439U30
9ASF4136E1448U30
9ASF4137E1457U30
9ASF4138E1466U30
9ASF4139E1475U30
9ASF4140E1484U30
9ASF4141E1493U30
9ASF4142E1502U30
9ASF4143E1511U30
9ASF4144E1520U30
9ASF4145E1529U30
9ASF4146E1538U30
9ASF4147E1547U30
9ASF4148E1556U30
9ASF4149E1565U30
9ASF4150E1574U30
9ASF4151E1583U30
9ASF4152E1592U30
9ASF4153E1601U30
9ASF4154E1610U30
9ASF4155E1619U30
9ASF4156E1628U30
9ASF4157E1637U30
9ASF4158E1646U30
9ASF4159E1655U30
9ASF4160E1664U30
9ASF4161E1673U30
9ASF4162E1682U30
9ASF4163E1691U30
9ASF4164E1700U30
9ASF4165E1709U30
9ASF4166E1718U30
9ASF4167E1727U30
9ASF4168E1736U30
9ASF4169E1745U30
9ASF4170E1754U30
9ASF4171E1763U30
9ASF4172E1772U30
9ASF4173E1781U30
9ASF4174E1790U30
9ASF4175E1799U30
9ASF4176E1808U30
9ASF4177E1817U30
9ASF4178E1826U30
9ASF4179E1835U30
9ASF4180E1844U30
9ASF4181E1853U30
9ASF4182E1862U30
9ASF4183E1871U30
9ASF4184E1880U30
9ASF4185E1889U30
9ASF4186E1898U30
9ASF4187E1907U30
9ASF4188E1916U30
9ASF4189E1925U30
9ASF4190E1934U30
9ASF4191E1943U30
9ASF4192E1952U30
9ASF4193E1961U30
9ASF4194E1970U30
9ASF4195E1979U30
9ASF4196E1988U30
9ASF4197E1997U30
9ASF4198E2006U30
9ASF4199E2015U30
9ASF4200E2024U30
9ASF4201E2033U30
9ASF4202E2042U30
9ASF4203E2051U30
9ASF4204E2060U30
9ASF4205E2069U30
9ASF4206E2078U30
9ASF4207E2087U30
9ASF4208E2096U30
9ASF4209E2105U30
9ASF4210E2114U30
9ASF4211E2123U30
9ASF4212E2132U30
9ASF4213E2141U30
9ASF4214E2150U30
9ASF4215E2159U30
9ASF4216E2168U30
9ASF4217E2177U30
9ASF4218E2186U30
9ASF4219E2195U30
9ASF4220E2204U30
9ASF4221E2213U30
9ASF4222E2222U30
9ASF4223E2231U30
9ASF4224E2240U30
9ASF4225E2249U30
9ASF4226E2258U30
9ASF4227E2267U30
9ASF4228E2276U30
9ASF4229E2285U30
9ASF4230E2294U30
9ASF4231E2303U30
9ASF4232E2312U30
9ASF4233E2321U30
9ASF4234E2330U30
9ASF4235E2339U30
9ASF4236E2348U30
9ASF4237E2357U30
9ASF4238E2366U30
9ASF4239E2375U30
9ASF4240E2384U30
9ASF4241E2393U30
9ASF4242E2402U30
9ASF4243E2411U30
9ASF4244E2420U30
9ASF4245E2429U30
9ASF4246E2438U30
9ASF4247E2447U30
9ASF4248E2456U30
9ASF4249E2465U30
9ASF4250E2474U30
9ASF4251E2483U30
9ASF4252E2492U30
9ASF4253E2501U30
9ASF4254E2510U30
9ASF4255E2519U30
9ASF4256E2528U30
9ASF4257E2537U30
9ASF4258E2546U30
9ASF4259E2555U30
9ASF4260E2564U30
9ASF4261E2573U30
9ASF4262E2582U30
9ASF4263E2591U30
9ASF4264E2600U30
9ASF4265E2609U30
9ASF4266E2618U30
9ASF4267E2627U30
9ASF4268E2636U30
9ASF4269E2645U30
9ASF4270E2654U30
9ASF4271E2663U30
9ASF4272E2672U30
9ASF4273E2681U30
9ASF4274E2690U30
9ASF4275E2699U30
9ASF4276E2708U30
9ASF4277E2717U30
9ASF4278E2726U30
9ASF4279E2735U30
9ASF4280E2744U30
9ASF4281E2753U30
9ASF4282E2762U30
9ASF4283E2771U30
9ASF4284E2780U30
9ASF4285E2789U30
9ASF4286E2798U30
9ASF4287E2807U30
9ASF4288E2816U30
9ASF4289E2825U30
9ASF4290E2834U30
9ASF4291E2843U30
9ASF4292E2852U30
9ASF4293E2861U30
9ASF4294E2870U30
9ASF4295E2879U30
9ASF4296E2888U30
9ASF4297E2897U30
9ASF4298E2906U30
9ASF4299E2915U30
9ASF4300E2924U30
9ASF4301E2933U30
9ASF4302E2942U30
9ASF4303E2951U30
9ASF4304E2960U30
9ASF4305E2969U30
9ASF4306E2978U30
9ASF4307E2987U30
9ASF4308E2996U30
9ASF4309E3005U30
9ASF4310E3014U30
9ASF4311E3023U30
9ASF4312E3032U30
9ASF4313E3041U30
9ASF4314E3050U30
9ASF4315E3059U30
9ASF4316E3068U30
9ASF4317E3077U30
9ASF4318E3086U30
9ASF4319E3095U30
9ASF4320E3104U30
9ASF4321E3113U30
9ASF4322E3122U30
9ASF4323E3131U30
9ASF4324E3140U30
9ASF4325E3149U30
9ASF4326E3158U30
9ASF4327E3167U30
9ASF4328E3176U30
9ASF4329E3185U30
9ASF4330E3194U30
9ASF4331E3203U30
9ASF4332E3212U30
9ASF4333E3221U30
9ASF4334E3230U30
9ASF4335E3239U30
9ASF4336E3248U30
9ASF4337E3257U30
9ASF4338E3266U30
9ASF4339E3275U30
9ASF4340E3284U30
9ASF4341E3293U30
9ASF4342E3302U30
9ASF4343E3311U30
9ASF4344E3320U30
9ASF4345E3329U30
9ASF4346E3338U30
9ASF4347E3347U30
9ASF4348E3356U30
9ASF4349E3365U30
9ASF4350E3374U30
9ASF4351E3383U30
9ASF4352E3392U30
9ASF4353E3401U30
9ASF4354E3410U30
9ASF4355E3419U30
9ASF4356E3428U30
9ASF4357E3437U30
9ASF4358E3446U30
9ASF4359E3455U30
9ASF4360E3464U30
9ASF4361E3473U30
9ASF4362E3482U30
9ASF4363E3491U30
9ASF4364E3500U30
9ASF4365E3509U30
9ASF4366E3518U30
9ASF4367E3527U30
9ASF4368E3536U30
9ASF4369E3545U30
9ASF4370E3554U30
9ASF4371E3563U30
9ASF4372E3572U30
9ASF4373E3581U30
9ASF4374E3590U30
9ASF4375E3599U30
9ASF4376E3608U30
9ASF4377E3617U30
9ASF4378E3626U30
9ASF4379E3635U30
9ASF4380E3644U30
9ASF4381E3653U30
9ASF4382E3662U30
9ASF4383E3671U30
9ASF4384E3680U30
9ASF4385E3689U30
9ASF4386E3698U30
9ASF4387E3707U30
9ASF4388E3716U30
9ASF4389E3725U30
9ASF4390E3734U30
9ASF4391E3743U30
9ASF4392E3752U30
9ASF4393E3761U30
9ASF4394E3770U30
9ASF4395E3779U30
9ASF4396E3788U30
9ASF4397E3797U30
9ASF4398E3806U30
9ASF4399E3815U30
9ASF4400E3824U30
9ASF4401E3833U30
9ASF4402E3842U30
9ASF4403E3851U30
9ASF4404E3860U30
9ASF4405E3869U30
9ASF4406E3878U30
9ASF4407E3887U30
9ASF4408E3896U30
9ASF4409E3905U30
9ASF4410E3914U30
9ASF4411E3923U30
9ASF4412E3932U30
9ASF4413E3941U30
9ASF4414E3950U30
9ASF4415E3959U30
9ASF4416E3968U30
9ASF4417E3977U30
9ASF4418E3986U30
9ASF4419E3995U30
9ASF4420E4004U30
9ASF4421E4013U30
9ASF4422E4022U30
9ASF4423E4031U30
9ASF4424E4040U30
9ASF4425E4049U30
9ASF4426E4058U30
9ASF4427E4067U30
9ASF4428E4076U30
9ASF4429E4085U30
9ASF4430E4094U30
9ASF4431E4103U30
9ASF4432E4112U30
9ASF4433E4121U30
9ASF4434E4130U30
9ASF4435E4139U30
9ASF4436E4148U30
9ASF4437E4157U30
9ASF4438E4166U30
9ASF4439E4175U30
9ASF4440E4184U30
9ASF4441E4193U30
9ASF4442E4202U30
9ASF4443E4211U30
9ASF4444E4220U30
9ASF4445E4229U30
9ASF4446E4238U30
9ASF4447E4247U30
9ASF4448E4256U30
9ASF4449E4265U30
9ASF4450E4274U30

References list

References list	References list	References list	References list	References list	References list
9AFB8E1169895C30	9ACB8B21358A7F30	9AGF8B----8--F30	9ALB8BBC6A845F30	TS040201W1000BD6	9BFF14
9AFBBE11698A3C30	9ACBBB21358B3F30	9AGG8A----8--F30	9ALBBBC6A8A0F30	TS040201W2000BD6	9BFH1
9AFB8W1102855C30	9ACB8B21698B2F30	9AGG8B----8--F30	9ALBBLBC6A8A4F30	TS040201W3000BD6	9BFH2
9AFBBW1102874C30	9ACBBB21698B9F30	9AGH8A----8--F30	9ALB2ACD6A828F30	TSR5003010200BK6	9BFP1
9AFB8W1135875C30	9ACB8A31028B0F30	9AGH8B----8--F30	9ALB8ACD6A862F30	TSR5003010500BK6	9BFP2
9AFBBW11358A0C30	9ACBBA31028B7F30	9AJA8A----8--F30	9ALBBACD6A8A4F30	TSR500301000BK6	9BFM1
9AFB8W1169895C30	9ACB8A31358B7F30	9AJA8B----8--F30	9ALBFACD6A8A9F30	TSR5003012000BK6	9BFM2
9AFBBW11698A3C30	9ACBBA31358C6F30	9AJB8A----8--F30	9ALB2BCD6A828F30	TSR5003013000BK6	9BFM3
9ABB8G1102855F30	9ACB8B31028B0F30	9AJB8B----8--F30	9ALB8BCD6A862F30	TNR60030C02001F4	9BFV1
9ABBBG1102874F30	9ACBBB31028B7F30	9AJC8A----8--F30	9ALBBBCD6A8A4F30	TNR60030C05001F4	9BFV2
9ABB8G1135875F30	9ACB8B31358B7F30	9AJC8B----8--F30	9ALBBLCD6A8A9F30	TNR60030C10001F4	9BFV3
9ABBBG11358A0F30	9ACBBB31358C6F30	9AJF8A----8--F30	9ALB2AEA6A850F30	TNR60030C20001F4	9V46004A0088C3E
9ABB8G1169895F30	9ACB8A41028B8F30	9AJF8B----8--F30	9ALB8AEA6A8--F30	TNR60030C30001F4	9V46004A0088C3U
9ABBBG11698A3F30	9ACB8B41028B8F30	9AJG8A----8--F30	9ALBBAAE6A8B5F30	2PE2N6	6YTMC2
9ABB8L1102855F30	9AQB8C1102855F30	9AJG8B----8--F30	9ALBFAE6A8C5F30	66MZ0060201257FW	9A66GT1
9ABBBL1102874F30	9AQBBC1102874F30	9AJH8A----8--F30	9ALB2BEG6A850F30	66MZ0060201257FX	
9ABB8L1135875F30	9AQB8C1135875F30	9AJH8B----8--F30	9ALB8BEG6A8A1F30	2PE2P6	
9ABBBL11358A0F30	9AQBBC11358A0F30	9AKB2GAB6A814F30	9ALBBBEG6A8B5F30	66MZ0060502001FW	
9ABB8L1169895F30	9AQB8C1169895F30	9AKB8GAB6A832F30	9ALBBLEG6A8C5F30	66MZ0060502001FX	
9ABBBL11698A3F30	9AQBBC11698A3F30	9AKBBGAB6A870F30	9AMB2CAB6A814F30	66EN1	
9ABB8G21028A3F30	9AQB8C21028A3F30	9AKBFGAB6A8A0F30	9AMB8CB6A832F30	66EN3	
9ABBGG21028A7F30	9AQBBC21028A7F30	9AKB2LAB6A814F30	9AMBBCAB6A870F30	2DNAP6FA	
9ABB8G21358A7F30	9AQB8C21358A7F30	9AKB8LAB6A832F30	9AMBCCB6A8A0F30	2DNAP6FB	
9ABBBG21358B3F30	9AQBBC21358B3F30	9AKBBLAB6A870F30	9AMB2CBC6A820F30	2DNAP6FI	
9ABB8G21698B2F30	9AQB8C21698B2F30	9AKBFLAB6A8A0F30	9AMB8CBC6A845F30	2DNAP6FJ	
9ABBBG21698B9F30	9AQBBC21698B9F30	9AKB2GBC6A820F30	9AMBBCBC6A8A0F30	273BN6F2	
9ABB8L21028A3F30	9AQB8C31028B0F30	9AKB8GBC6A845F30	9AMBBCBC6A8A4F30	273BP0F2	
9ABBBL21028A7F30	9AQBBC31028B7F30	9AKBBGBC6A8A0F30	9AMB2CCD6A828F30	273BK1F2	
9ABB8L21358A7F30	9AQB8C31358B7F30	9AKBFGBC6A8A4F30	9AMB8CCD6A862F30	244CUUB	
9ABBBL21358B3F30	9AQBBC31358C6F30	9AKB2LBC6A820F30	9AMBCCD6A8A4F30	Y22D9Z00805HCSV0	
9ABB8L21698B2F30	9AQB8C41028B8F30	9AKB8LBC6A845F30	9AMBCCD6A8A9F30	Y22D9P01006CUSV0	
9ABBBL21698B9F30	9ARA80----8--450	9AKBBLBC6A8A0F30	9AMB2CEG6A850F30	Y22D9J01006CUSV0	
9ABB8G31028B0F30	9ARA80----8--C30	9AKBFLBC6A8A4F30	9AMB8CEG6A8A1F30	Y8WHQ02101000AUV	
9ABBBG31028B7F30	9ARB80----8--450	9AKB2GCD6A828F30	9AMBBCEG6A8B5F30	Y8WHS02101000AUV	
9ABB8G31358B7F30	9ARB80----8--C30	9AKB8GCD6A862F30	9AMBCEG6A8C5F30	Y8WHS02181000DUV	
9ABBBG31358C6F30	9ARC80----8--450	9AKBBGCD6A8A4F30	UJA	Y8WHT02101000AUV	
9ABB8L31028B0F30	9ARC80----8--C30	9AKBFGCD6A8A9F30	4A	Y8WHT02181000DUV	
9ABBBL31028B7F30	9ARF80----8--450	9AKB2LCD6A828F30	4T	Y8WHQ02101000AUQ	
9ABB8L31358B7F30	9ARF80----8--C30	9AKB8LCD6A862F30	4903	Y8WHS02101000AUQ	
9ABBBL31358C6F30	9ARG80----8--450	9AKBBLCD6A8A4F30	4R05	Y8WHS02181000DUQ	
9ABB8G41028B8F30	9ARG80----8--C30	9AKBFLCD6A8A9F30	IBK2000632313001	Y8WHT02101000AUQ	
9ABB8L41028B8F30	9ARH80----8--450	9AKB2GEG6A850F30	IBK2000632313901	Y8WHT02181000DUQ	
9ACB8A1102855F30	9ARH80----8--C30	9AKB8GEG6A8--F30	66MB0600000010MW	Y8WJU021D1000FUV	
9ACBBA1102874F30	9AEA8G----8--F30	9AKBBGEG6A8B5F30	8GB030110AA80001	Y8WJU021D1000FUS	
9ACB8A1135875F30	9AEA8L----8--F30	9AKBFGEG6A8C5F30	8GB050200AA60001	Y8WJU021D1000FUU	
9ACBBA11358A0F30	9AEB8G----8--F30	9AKB2LEG6A850F30	66MZ0060301101FW	Y8WJU021D1000FUT	
9ACB8A1169895F30	9AEB8L----8--F30	9AKB8LEG6A8A1F30	66MZ0060502001FW	9BFL1	
9ACBBA11698A3F30	9AEC8G----8--F30	9AKBBLLEG6A8B5F30	66MZ0060502001FX	9BFL5	
9ACB8B1102855F30	9AEC8L----8--F30	9AKBFLEG6A8C5F30	66MZ0060502001FX	9BFL6	
9ACBBB1102874F30	9AEF8G----8--F30	9ALB2AAB6A814F30	8CB030110AA60001	9BFL2	
9ACB8B1135875F30	9AEF8L----8--F30	9ALB8AAB6A832F30	8CB050200AA60001	9BFL3	
9ACBBB11358A0F30	9AEG8G----8--F30	9ALBBAAB6A870F30	66MZ0060301101FW	9BFL4	
9ACB8B1169895F30	9AEG8L----8--F30	9ALBFAAB6A8A0F30	66MZ0060502001FW	9BFL7	
9ACBBB11698A3F30	9AEH8G----8--F30	9ALB2BAB6A814F30	66MZ0060502001FX	9BFL8	
9ACB8A21028A3F30	9AEH8L----8--F30	9ALB8BAB6A832F30	66MZ0060502001FX	9BFS1	
9ACBBA21028A7F30	9AGA8A----8--F30	9ALBBBAB6A870F30	TPR00060W02002F4	9BFS2	
9ACB8A21358A7F30	9AGA8B----8--F30	9ALBBLAB6A8A0F30	TPR00060W05002F4	9BFS3	
9ACBBA21358B3F30	9AGB8A----8--F30	9ALB2ABC6A820F30	TPR00060W10002F4	9BFS4	
9ACB8A21698B2F30	9AGB8B----8--F30	9ALB8ABC6A845F30	TPR00060W20002F4	9BFS5	
9ACBBA21698B9F30	9AGC8A----8--F30	9ALBBABC6A8A0F30	TPR00060W30002F4	9BFS6	
9ACB8B21028A3F30	9AGC8B----8--F30	9ALBFABC6A8A4F30	TS040201W0200BD6	9BFS7	
9ACBBB21028A7F30	9AGF8A----8--F30	9ALB2BBC6A820F30	TS040201W0500BD6	9BFF4	
				9BFF10	

Because of permanent improvement of our products, drawings, descriptions, features used on these data sheets are for guidance only and can be modified without prior advice



Flexible silicone rubber ribbons for heat tracing



Safety instructions for all industrial silicone rubber ribbon heaters described in this catalogue section

General conditions

- 1- Read the user manual before any use
- 2- Protect the power supply circuit by a differential circuit breaker of 20mA sensitivity, with rating adapted to the model that must be connected to it.
- 3- This power supply supply circuit must be carried out by a qualified electrician and according to the local standards in force.
- 4-The earth circuit must be compliant and connected.
- 5- Check that power supply voltage is the same than printed on the heater.
- 6- Don't use silicone rubber heaters with surface power higher than 0.2 W/cm² on plastic surfaces.
- 7- The heater must be disconnected during installation or de-installation.
- 8-The heater must be stored in a dry place and protected from rodents and other animals during periods when it is not used.
- 9- Do not cut or punch the surface
- 10- Silicone heaters are not suitable for prolonged exposure to oils.
- 11- These devices are not suitable for use in flammable or explosive areas.

Additional instructions for heating ribbons

- 12- Do not operate above rated safety temperature of the product. (This temperature must be checked before connecting the device).
- 13- The silicone heater must be in contact with the surface to be heated, without superimposing heating parts. The superposition of two heating parts doubles the surface power and can cause melting of the silicone heater and initiate a fire in the most severe cases.
- 14- Heated surface must be clean and not greasy.
- 15- Position the silicone heater so that it is in perfect contact with the largest possible surface to be heated.
- 16- Do not wrap on handles, fittings, taps, legs, plugs, rivets, screws or any surface irregularity.
- 17- Never immerse the heater in liquids or water. It is not immersion proof. If it must be cleaned, disconnect from power supply before cleaning and clean it with soft tissue.
- 18- Do not use on square or rectangular pipes with sharp angles. Angles must have a radius greater than 20mm.

NT3000SPH037A



Heating flat ribbons in silicone, width 15 mm, maximum length 10m, for electric tracing. **Without thermostats.**

Walls material	Maximum temperature	Tightening	Thermostat	Silicone thickness (mm)	Type
Metal or plastic	200°C	Optional adhesive side	Without thermostat, but K thermocouple in option	1,6 2,5	9AS

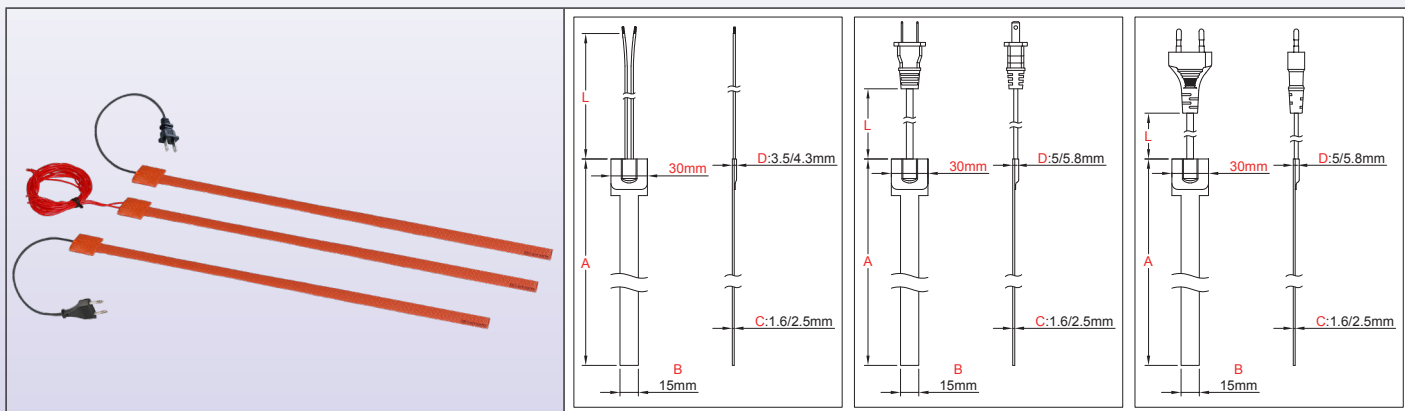

Main features

Silicone rubber ribbons are made of fiberglass reinforced laminated silicone rubber sheets, vulcanized together through heat and high pressure on both sides of an embedded specially formed heating wire element. Fiberglass-reinforced silicone rubber gives the heater dimensional stability without sacrificing flexibility.

Silicone is used because of its high temperature resistance (Permanent temperature up to 200°C /390°F), high thermal conductivity ($\sim 7 \cdot 10^{-4} \text{W/cm.K}$) and good electrical insulation properties ($\sim 12 \text{KV/mm}$)

This series is distinguished by its small width allowing it to be wound around pipes for electrical tracing applications. Heating elements of this series can be made with constant power when the temperature rise, or with positive temperature coefficient reducing the power when the temperature rises.

Other general particularities of these heaters are:

- Not affected by vibration or flexing,
- Lightweight,
- Comply with UL94-VO (flame retardant) and ROHS,
- Low smoke and low Toxicity,
- Silicone is non-toxic, and moisture and chemical resistant,
- Very thin profile

Main Applications

Some typical applications examples are:

Provide process temperature maintenance or avoid freezing to metallic and plastic piping, gutters, valves, pumps, water meters. These ribbons are usually wrapped around the pipe or equipment, but can also be mounted longitudinally. **Unlike self-regulating heating cords using PTC plastic compounds, they are not subject to a drift in their characteristics over time,** and they exist in a wider surface power range.

Technical Features

Clamping: Installation is usually done on pipes, with fiberglass reinforced tape, or using adhesive heater.

Length (Dimension A): 2.5m, 5m, 10m

Width: 15 mm

Silicone foil minimum bending radius: 3.2 mm (0.125")

Ingress protection: IP65.

Minimum ambient temperature: -10°C (+15°F)

Voltage: 220-240VAC.

Power tolerance: $\pm 10\%$ at 20°C

Temperature control: No thermostat or high limit switch available on these products (Width is not enough for them). K thermocouple sensor can be embedded on request and then allows electronic temperature control. For simple applications in antifreeze applications, it is also possible to use a waterproof fixed setting thermostat control box type Y22. (See accessories in the last section of this catalogue).

Power density: from 0.1W/cm^2 (0.65W/inch^2) to 0.8W/cm^2 (5.2W/inch^2). See part numbers table.

Don't use power density higher than 0.2W/cm^2 on plastic walls. Check the surface temperature rise versus surface power density. (Table is available in the technical introduction).

Thickness of the flexible silicone foil: 1.6 or 2.5mm.

Quality control routine tests: Each heating element is 100% tested for continuity, resistance and insulation. Tests are made according to EN 60335-1 and EN 50106 standards. See technical introduction.

Dielectric Strength: 1750V AC.



Heating flat ribbons in silicone, width 15 mm, maximum length 10m, for electric tracing. **Without thermostats.**

Insulation resistance: ≥ 10 Megohms.

Operating temperature:

The temperature of the heated product is generally much lower than that of the surface and depends mainly on the surface power (W/cm²), the quality of the thermal contact, the viscosity, heat capacity and thermal conductivity of the heated product, the good positioning of the heater, the ambient temperature, and the fluid speed inside the pipe.

You can find in the technical introduction examples of the temperatures reached by silicone rubber heaters. They represent the temperature that may reach the heating element if it is not correctly installed.

Connection:

- 2 AWG18 or 0.75mm² FEP insulated wires, length 500mm (other lengths on request).

- 2 x AWG 18 or 2x 0.75mm² cord with euro plug or UL plug (2 prongs).

Options:

- Power supply 110/115V

- Grounded mesh wire shield layer

Safety standards:

The heaters have been designed in compliance with EEC Low Voltage Directive (LVD) 2006/95/EC and EMC directive 2004/108/EC. They must be installed in accordance with all local applicable instructions, codes, and regulations.

Main curves of positive temperature coefficient alloys (self-regulating effect)

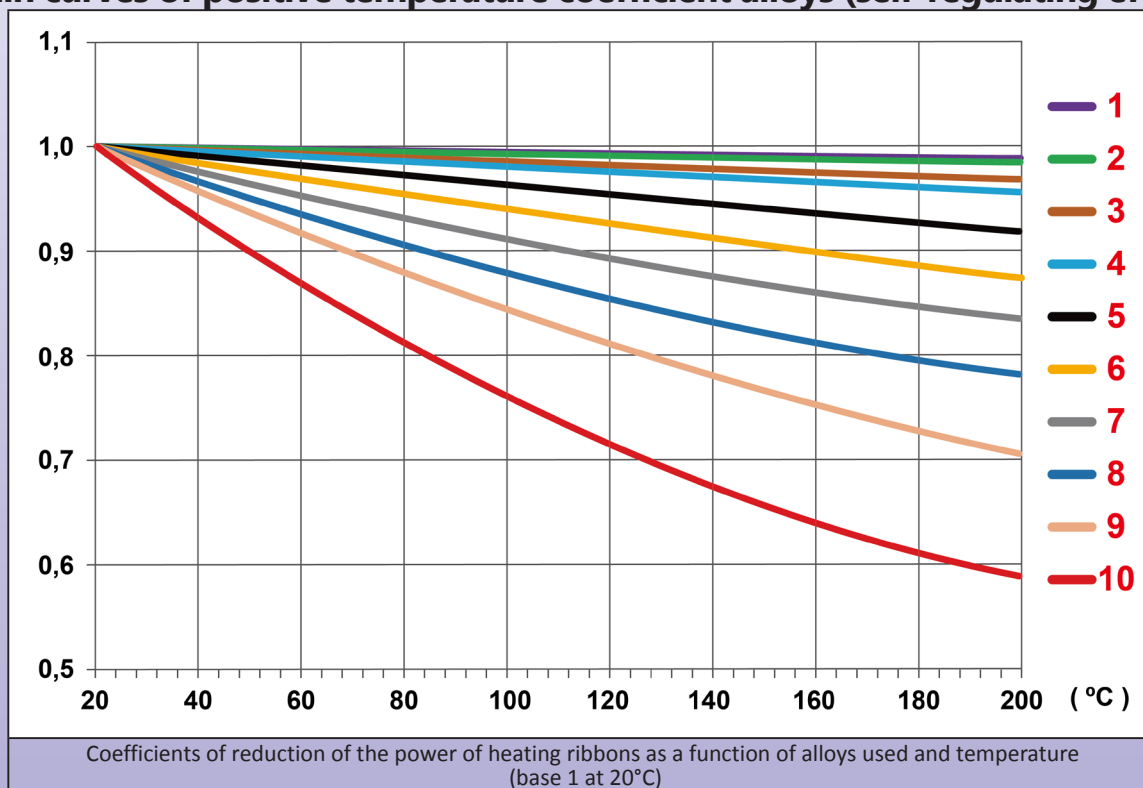

Main parts numbers in 220/240V with 3m euro plug cord *

(Surface temperatures reached versus power surface density are described in the technical introduction)

Heaters without change in power when temperature rises								
A Length m (inch)	Power density W/cm ² (W/in ²)	Total Power** Watts	Power per meter W/m	PTC curve	Part numbers without adhesive, without K sensor	Part numbers with adhesive, without K sensor	Part numbers without adhesive, with K sensor	Part numbers with adhesive, with K sensor
2,5 (98.5)	0.2 (1.3)	40	18	1	9ASA2011B5804U30	9ASF2011B5804U30	9ASA2K11B5804U30	9ASF2K11B5804U30
2,5 (98.5)	0.3 (1.9)	70	27	1	9ASA3011B5807U30	9ASF3011B5807U30	9ASA3K11B5807U30	9ASF3K11B5807U30
2,5 (98.5)	0.4 (2.6)	90	36	1	9ASA4011B5809U30	9ASF4011B5809U30	9ASA4K11B5809U30	9ASF4K11B5809U30
2,5 (98.5)	0.5 (3.2)	110	45	1	9ASA5011B5811U30	9ASF5011B5811U30	9ASA5K11B5811U30	9ASF5K11B5811U30
2,5 (98.5)	0.6 (3.9)	130	54	1	9ASA6011B5813U30	9ASF6011B5813U30	9ASA6K11B5813U30	9ASF6K11B5813U30
2,5 (98.5)	0.7 (4.5)	160	63	1	9ASA7011B5816U30	9ASF7011B5816U30	9ASA7K11B5816U30	9ASF7K11B5816U30
2,5 (98.5)	0.8 (5.2)	180	72	1	9ASA8011B5818U30	9ASF8011B5818U30	9ASA8K11B5818U30	9ASF8K11B5818U30
5 (197)	0.1 (0.65)	40	9	1	9ASA1011E0804U30	9ASF1011E0804U30	9ASA1K11E0804U30	9ASF1K11E0804U30
5 (197)	0.2 (1.3)	90	18	2	9ASA2021E0809U30	9ASF2021E0809U30	9ASA2K21E0809U30	9ASF2K21E0809U30
5 (197)	0.3 (1.9)	130	27	2	9ASA3021E0813U30	9ASF3021E0813U30	9ASA3K21E0813U30	9ASF3K21E0813U30
5 (197)	0.4 (2.6)	180	36	2	9ASA4021E0818U30	9ASF4021E0818U30	9ASA4K21E0818U30	9ASF4K21E0818U30
5 (197)	0.5 (3.2)	220	45	1	9ASA5013E0822U30	9ASF5013E0822U30	9ASA5K13E0822U30	9ASF5K13E0822U30

Because of permanent improvement of our products, drawings, descriptions, features used on these data sheets are for guidance only and can be modified without prior advice



Heating flat ribbons in silicone, width 15 mm, maximum length 10m, for electric tracing. **Without thermostats.**

Because of permanent improvement of our products, drawings, descriptions, features used on these data sheets are for guidance only and can be modified without prior advice

Heaters without change in power when temperature rises								
A Length m (inch)	Power density W/cm ² (W/in ²)	Total Power** Watts	Power per meter W/m	PTC curve	Part numbers without adhesive, without K sensor	Part numbers with adhesive, without K sensor	Part numbers without adhesive, with K sensor	Part numbers with adhesive, with K sensor
5 (197)	0.6 (3.9)	270	54	1	9ASA6013E0827U30	9ASF6013E0827U30	9ASA6K13E0827U30	9ASF6K13E0827U30
5 (197)	0.7 (4.5)	310	63	1	9ASA7015E0831U30	9ASF7015E0831U30	9ASA7K15E0831U30	9ASF7K15E0831U30
5 (197)	0.8 (5.2)	360	72	2	9ASA8026E0818U30	9ASF8026E0818U30	9ASA8K26E0818U30	9ASF8K26E0818U30
10 (394)	0.1 (0.65)	90	9	2	9ASA1021J0809U30	9ASF1021J0809U30	9ASA1K21J0809U30	9ASF1K21J0809U30
10 (394)	0.2 (1.3)	180	18	2	9ASA2022J0818U30	9ASF2022J0818U30	9ASA2K22J0818U30	9ASF2K22J0818U30
10 (394)	0.3 (1.9)	270	27	2	9ASA3023J0818U30	9ASF3023J0818U30	9ASA3K23J0818U30	9ASF3K23J0818U30
10 (394)	0.4 (2.6)	360	36	2	9ASA4025J0836U30	9ASF4025J0836U30	9ASA4K25J0836U30	9ASF4K25J0836U30
10 (394)	0.5 (3.2)	450	45	2	9ASA5025J0845U30	9ASF5025J0845U30	9ASA5K25J0845U30	9ASF5K25J0845U30
10 (394)	0.6 (3.9)	540	54	2	9ASA6025J0854U30	9ASF6025J0854U30	9ASA6K25J0854U30	9ASF6K25J0854U30
10 (394)	0.7 (4.5)	630	63	2	9ASA7025J0863U30	9ASF7025J0863U30	9ASA7K25J0863U30	9ASF7K25J0863U30
10 (394)	0.8 (5.2)	720	72	2	9ASA8025J0872U30	9ASF8025J0872U30	9ASA8K25J0872U30	9ASF8K25J0872U30

Heaters with change in power when temperature rises (PTC, positive temperature coefficient)								
A Length m (inch)	Power density W/cm ² (W/in ²)	Total Power** Watts	Power per meter W/m	PTC curve	Part numbers without adhesive, without K sensor	Part numbers with adhesive, without K sensor	Part numbers without adhesive, with K sensor	Part numbers with adhesive, with K sensor
2,5 (98.5)	0.4 (2.6)	90	36	6	9ASA4061B5809U30	9ASF4061B5809U30	9ASA4K61B5809U30	9ASF4K61B5809U30
2,5 (98.5)	0.5 (3.2)	110	45	6	9ASA5061B5811U30	9ASF5061B5811U30	9ASA5K61B5811U30	9ASF5K61B5811U30
2,5 (98.5)	0.6 (3.9)	130	54	6	9ASA6061B5813U30	9ASF6061B5813U30	9ASA6K61B5813U30	9ASF6K61B5813U30
2,5 (98.5)	0.7 (4.5)	160	63	6	9ASA7061B5816U30	9ASF7061B5816U30	9ASA7K61B5816U30	9ASF7K61B5816U30
2,5 (98.5)	0.8 (5.2)	180	72	6	9ASA8061B5818U30	9ASF8061B5818U30	9ASA8K61B5818U30	9ASF8K61B5818U30
5 (197)	0.1 (0.65)	40	9	6	9ASA4061E0804U30	9ASF4061E0804U30	9ASA4K61E0804U30	9ASF4K61E0804U30
5 (197)	0.2 (1.3)	90	18	6	9ASA4062E0809U30	9ASF4062E0809U30	9ASA4K62E0809U30	9ASF4K62E0809U30
5 (197)	0.3 (1.9)	130	27	6	9ASA4062E0813U30	9ASF4062E0813U30	9ASA4K62E0813U30	9ASF4K62E0813U30
5 (197)	0.4 (2.6)	180	36	6	9ASA4064E0818U30	9ASF4064E0818U30	9ASA4K64E0818U30	9ASF4K64E0818U30
5 (197)	0.5 (3.2)	220	45	6	9ASA5064E0822U30	9ASF5064E0822U30	9ASA5K64E0822U30	9ASF5K64E0822U30
5 (197)	0.6 (3.9)	270	54	6	9ASA6064E0827U30	9ASF6064E0827U30	9ASA6K64E0827U30	9ASF6K64E0827U30
5 (197)	0.7 (4.5)	310	63	6	9ASA7064E0831U30	9ASF7064E0831U30	9ASA7K64E0831U30	9ASF7K64E0831U30
5 (197)	0.8 (5.2)	360	72	6	9ASA8064E0836U30	9ASF8064E0836U30	9ASA8K64E0836U30	9ASF8K64E0836U30
10 (394)	0.1 (0.65)	90	9	6	9ASA1062J0809U30	9ASF1062J0809U30	9ASA1K62J0809U30	9ASF1K62J0809U30
10 (394)	0.2 (1.3)	180	18	10	9ASA20A1J0818U30	9ASF20A1J0818U30	9ASA2KA1J0818U30	9ASF2KA1J0818U30
10 (394)	0.3 (1.9)	270	27	10	9ASA30A1J0827U30	9ASF30A1J0827U30	9ASA3KA1J0827U30	9ASF3KA1J0827U30
10 (394)	0.4 (2.6)	360	36	10	9ASA40A1J0836U30	9ASF40A1J0836U30	9ASA4KA1J0836U30	9ASF4KA1J0836U30
10 (394)	0.5 (3.2)	450	45	10	9ASA50A1J0845U30	9ASF50A1J0845U30	9ASA5KA1J0845U30	9ASF5KA1J0845U30
10 (394)	0.6 (3.9)	540	54	10	9ASA60A1J0854U30	9ASF60A1J0854U30	9ASA6KA1J0854U30	9ASF6KA1J0854U30
10 (394)	0.7 (4.5)	630	63	10	9ASA70A2J0863U30	9ASF70A2J0863U30	9ASA7KA2J0863U30	9ASF7KA2J0863U30
10 (394)	0.8 (5.2)	720	72	10	9ASA80A2J0872U30	9ASF80A2J0872U30	9ASA8KA2J0872U30	9ASF8KA2J0872U30

* Cord with UL plug instead of Euro plug, replace U30 by R30 in the part number.

Output with 2 AWG18 (0.75mm²) wires, 500mm long instead of euro plug with 3 meters cord, replace U30 by 450 in the part number

** Values above 800W are not compatible with this series

*** 2.5mm thickness instead 1.6mm, replace 9ASA by 9ASB or 9ASF by 9ASG in the part number.



Contact us

Web: www.ultimheat.com

Cat25-2-4-5

Heating flat ribbons in silicone, width 35 mm, maximum length 10m, for electric tracing.

Walls material	Maximum temperature	Tightening	Thermostat	Silicone thickness (mm)	Type
Metal or plastic	200°C	Optional adhesive side	With or without built-in fixed setting thermostat or limiter, and K thermocouple in option	1,6 2,5	9AD

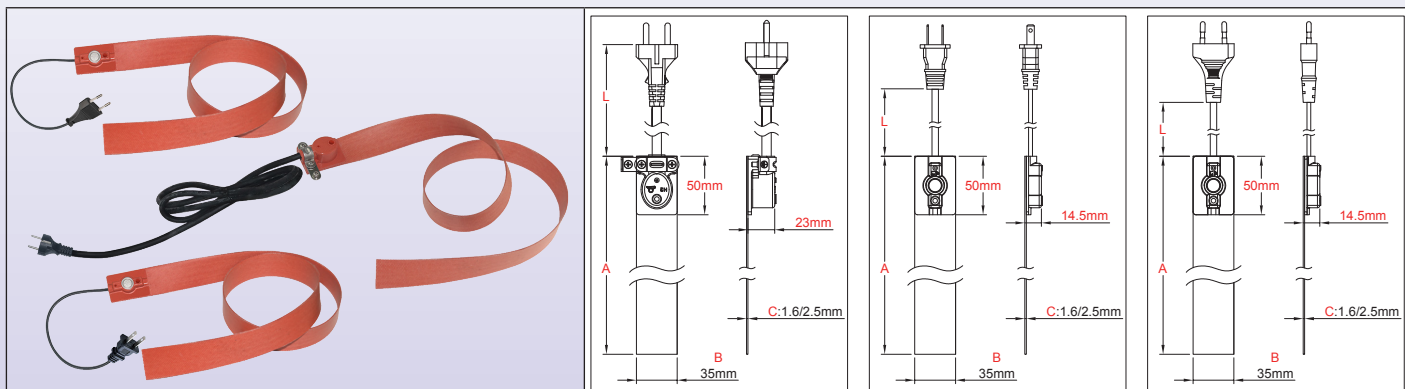

Main features

Silicone rubber ribbons are made of fiberglass reinforced laminated silicone rubber sheets, vulcanized together through heat and high pressure on both sides of an embedded specially formed heating wire element. Fiberglass-reinforced silicone rubber gives the heater dimensional stability without sacrificing flexibility.

Silicone is used because of its high temperature resistance (Permanent temperature up to 200°C /390°F), high thermal conductivity (~7 10⁻⁴ W/cm.K) and good electrical insulation properties (~12KV/mm)

This series is distinguished by its 35mm width allowing it to be wound around pipes for electrical tracing applications. This width also allows to embed fixed setting thermostats or temperature limiters on the heater surface.

Heating elements of this series can be made with constant power when the temperature rise, or with positive temperature coefficient reducing the power when the temperature rises.

Other general particularities of these heaters are:

- Not affected by vibration or flexing,
- Lightweight,
- Comply with UL94-VO (flame retardant) and ROHS,
- Low smoke and low Toxicity,
- Silicone is non-toxic, and moisture and chemical resistant,
- Very thin profile

Main Applications

Some typical applications examples are:

Provide process temperature maintenance or avoid freezing to metallic and plastic piping, gutters, valves, pumps, water meters. These ribbons are usually wrapped around the pipe or equipment, but can also be mounted longitudinally. **Unlike self-regulating heating cords using PTC plastic compounds, they are not subject to a drift in their characteristics over time,** and they exist in a wider surface power range.

Technical Features

Clamping: Installation is usually done on pipes, with fiberglass reinforced tape, or using adhesive heater.

Length (Dimension A): 2.5m, 5m, 10m

Width: 35 mm

Silicone foil minimum bending radius: 3.2 mm (0.125")

Ingress protection: IP65.

Minimum ambient temperature: -10°C (+15°F)

Voltage: 220-240VAC.

Power tolerance: ±10% at 20°C

Temperature limiters: This series can receive many temperature limiters models. They are described in the section 7 of this catalogue

Temperature control: By fixed setting bimetal thermostat, switches on the heating at 4 +/-3°C (39+/-5°F), switches it off at 10+/-3°C (50+/-5°F), electric rating 10A 250V. K thermocouple sensor can be embedded on request and then allows electronic temperature control. In this version, the bimetal thermostat is removed.

Power density: from 0.1W/cm² (0.65W/inch²) to 0.8W/cm² (5.2 W/inch²). See part numbers table.

Don't use power density higher than 0.2W/cm² on plastic walls. Check the surface temperature rise versus surface power density. (Table is available in the technical introduction).

Because of permanent improvement of our products, drawings, descriptions, features used on these data sheets are for guidance only and can be modified without prior advice



Heating flat ribbons in silicone, width 35 mm, maximum length 10m, for electric tracing.

Thickness of the flexible silicone foil: 1.6 mm (economical types) or 2.5mm (reinforced models).

Quality control routine tests: Each heating element is 100% tested for continuity, resistance and insulation. Tests are made according to EN 60335-1 and EN 50106 standards. See technical introduction.

Dielectric Strength: 1750V AC.

Insulation resistance: ≥ 10 Megohms.

Operating temperature:

The temperature of the heated product is generally much lower than that of the surface and depends mainly on the surface power (W/cm^2), the quality of the thermal contact, the viscosity, heat capacity and thermal conductivity of the heated product, the good positioning of the heater the ambient temperature, and the fluid speed inside the pipe.

You can find in the technical introduction examples of the temperatures reached by silicone rubber heaters. They represent the temperature that may reach the heating element if it is not correctly installed.

Connection:

- 2 wires $0.75mm^2$ (AWG18), FEP insulated, length 500mm (other lengths on request).

- 2 x $0.75mm^2$ (AWG18), 3m cord, with euro plug or UL plug (2 prongs).

- Above 1250W (6A) the wire gauge becomes $1mm^2$ (AWG16)

- 3 x $1mm^2$ (3xAWG16) 3 m cord, rubber insulated, with euro or UL plug (3 prongs), or without plug.

Options:

- Power supply 110/115V

- Grounded mesh wire shield layer

Safety standards:

The heaters have been designed in compliance with EEC Low Voltage Directive (LVD) 2006/95/EC and EMC directive 2004/108/EC. They must be installed in accordance with all local applicable instructions, codes, and regulations.

Main curves of positive temperature coefficient alloys (self-regulating effect)

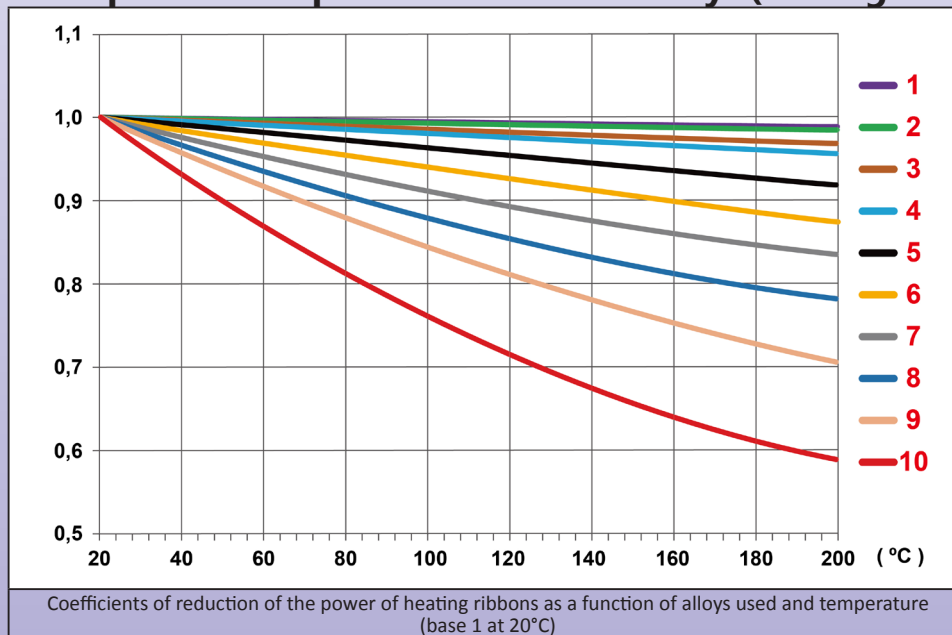

Main parts numbers in 220/240V with 3m euro plug cord *

(Surface temperatures reached versus power surface density are described in the technical introduction)

Heaters without change in power when temperature rises								
A Length m (inch)	Power density W/cm^2 (W/in^2)	Total Power** Watts	Power per meter W/m	PTC curve	Part numbers with antifreeze thermostat at 4°C, without adhesive, without K sensor	Part numbers with antifreeze thermostat at 4°C, with adhesive, without K sensor	Part numbers without antifreeze thermostat at 4°C, without adhesive, with K sensor	Part numbers without antifreeze thermostat at 4°C, with adhesive, with K sensor
2,5 (98.5)	0.1 (0.65)	60	25	1	9ADA1211B5806U30	9ADF1211B5806U30	9ADA1K11B5806U30	9ADF1K11B5806U30
2,5 (98.5)	0.2 (1.3)	120	50	1	9ADA2212B5812U30	9ADF2212B5812U30	9ADA2K12B5812U30	9ADF2K12B5812U30
2,5 (98.5)	0.3 (1.9)	180	75	1	9ADA3213B5818U30	9ADF3213B5818U30	9ADA3K13B5818U30	9ADF3K13B5818U30
2,5 (98.5)	0.4 (2.6)	250	100	1	9ADA4213B5825U30	9ADF4213B5825U30	9ADA4K13B5825U30	9ADF4K13B5825U30
2,5 (98.5)	0.5 (3.2)	310	125	1	9ADA5214B5831U30	9ADF5214B5831U30	9ADA5K14B5831U30	9ADF5K14B5831U30
2,5 (98.5)	0.6 (3.9)	370	150	1	9ADA6215B5837U30	9ADF6215B5837U30	9ADA6K15B5837U30	9ADF6K15B5837U30
2,5 (98.5)	0.7 (4.5)	430	175	1	9ADA7216B5843U30	9ADF7216B5843U30	9ADA7K16B5843U30	9ADF7K16B5843U30
2,5 (98.5)	0.8 (5.2)	500	200	1	9ADA8216B5850U30	9ADF8216B5850U30	9ADA8K16B5850U30	9ADF8K16B5850U30
5 (197)	0.1 (0.65)	120	25	1	9ADA1213E0812U30	9ADF1213E0812U30	9ADA1K13E0812U30	9ADF1K13E0812U30
5 (197)	0.2 (1.3)	250	50	2	9ADA2224E0825U30	9ADF2224E0825U30	9ADA2K24E0825U30	9ADF2K24E0825U30



Heating flat ribbons in silicone, width 35 mm, maximum length 10m, for electric tracing.

Heaters without change in power when temperature rises								
A Length m (inch)	Power density W/cm ² (W/in ²)	Total Power** Watts	Power per meter W/m	PTC curve	Part numbers with antifreeze thermostat at 4°C, without adhesive, without K sensor	Part numbers with antifreeze thermostat at 4°C, with adhesive, without K sensor	Part numbers without antifreeze thermostat at 4°C, without adhesive, with K sensor	Part numbers without antifreeze thermostat at 4°C, with adhesive, with K sensor
5 (197)	0.3 (1.9)	370	75	2	9ADA3224E0837U30	9ADF3224E0837U30	9ADA1K24E0837U30	9ADF3K24E0837U30
5 (197)	0.4 (2.6)	500	100	2	9ADA4224E0850U30	9ADF4224E0850U30	9ADA4K24E0850U30	9ADF4K24E0850U30
5 (197)	0.5 (3.2)	620	125	2	9ADA5225E0862U30	9ADF5225E0862U30	9ADA5K25E0862U30	9ADF5K25E0862U30
5 (197)	0.6 (3.9)	750	150	2	9ADA6226E0875U30	9ADF6226E0875U30	9ADA6K26E0875U30	9ADF6K26E0875U30
5 (197)	0.7 (4.5)	870	175	3	9ADA7236E0887U30	9ADF7236E0887U30	9ADA7K36E0887U30	9ADF7K36E0887U30
5 (197)	0.8 (5.2)	990	200	3	9ADA8236E0899U30	9ADF8236E0899U30	9ADA8K36E0899U30	9ADF8K36E0899U30
10 (394)	0.1 (0.65)	250	25	3	9ADA1233J0825U30	9ADF1233J0825U30	9ADA1K33J0825U30	9ADF1K33J0825U30
10 (394)	0.2 (1.3)	500	50	3	9ADA2235J0850U30	9ADF2235J0850U30	9ADA2K35J0850U30	9ADF2K35J0850U30
10 (394)	0.3 (1.9)	750	75	4	9ADA3246J0875U30	9ADF3246J0875U30	9ADA3K46J0875U30	9ADF3K46J0875U30
10 (394)	0.4 (2.6)	1000	100	4	9ADA4246J08A0U30	9ADF4246J08A0U30	9ADA4K46J08A0U30	9ADF4K46J08A0U30
10 (394)	0.5 (3.2)	1250	125	4	9ADA5246J08A3U30	9ADF5246J08A3U30	9ADA5K46J08A3U30	9ADF5K46J08A3U30
10 (394)	0.6 (3.9)	1500	150	5	9ADA6256J08A5U30	9ADF6256J08A5U30	9ADA6K56J08A5U30	9ADF6K56J08A5U30
10 (394)	0.7 (4.5)	1750	175	5	9ADA7256J08A8U30	9ADF7256J08A8U30	9ADA7K56J08A8U30	9ADF7K56J08A8U30
10 (394)	0.8 (5.2)	2000	200	5	9ADA8256J08B0U30	9ADF8256J08B0U30	9ADA8K56J08B0U30	9ADF8K56J08B0U30

Heaters with change in power when temperature rises (PTC, positive temperature coefficient)								
A Length m (inch)	Power density W/cm ² (W/in ²)	Total Power** Watts	Power per meter W/m	PTC curve	Part numbers with antifreeze thermostat at 4°C, without adhesive, without K sensor	Part numbers with antifreeze thermostat at 4°C, with adhesive, without K sensor	Part numbers without antifreeze thermostat at 4°C, without adhesive, with K sensor	Part numbers without antifreeze thermostat at 4°C, with adhesive, with K sensor
2,5 (98.5)	0.1 (0.65)	60	25	6	9ADA1261B5806U30	9ADF1261B5806U30	9ADA1K61B5806U30	9ADF1K61B5806U30
2,5 (98.5)	0.2 (1.3)	120	50	6	9ADA2261B5812U30	9ADF2261B5812U30	9ADA2K61B5812U30	9ADF2K61B5812U30
2,5 (98.5)	0.3 (1.9)	180	75	6	9ADA3261B5818U30	9ADF3261B5818U30	9ADA3K61B5818U30	9ADF3K61B5818U30
2,5 (98.5)	0.4 (2.6)	250	100	6	9ADA4262B5825U30	9ADF4262B5825U30	9ADA4K62B5825U30	9ADF4K62B5825U30
2,5 (98.5)	0.5 (3.2)	310	125	6	9ADA5262B5831U30	9ADF5262B5831U30	9ADA5K62B5831U30	9ADF5K62B5831U30
2,5 (98.5)	0.6 (3.9)	370	150	6	9ADA6262B5837U30	9ADF6262B5837U30	9ADA6K62B5837U30	9ADF6K62B5837U30
2,5 (98.5)	0.7 (4.5)	430	175	6	9ADA7263B5843U30	9ADF7263B5843U30	9ADA7K63B5843U30	9ADF7K63B5843U30
2,5 (98.5)	0.8 (5.2)	500	200	6	9ADA8263B5850U30	9ADF8263B5850U30	9ADA8K63B5850U30	9ADF8K63B5850U30
5 (197)	0.1 (0.65)	120	25	10	9ADA12A1E0812U30	9ADF12A1E0812U30	9ADA1KA1E0812U30	9ADF1KA1E0812U30
5 (197)	0.2 (1.3)	250	50	10	9ADA22A1E0825U30	9ADF22A1E0825U30	9ADA2KA1E0825U30	9ADF2KA1E0825U30
5 (197)	0.3 (1.9)	370	75	10	9ADA32A2E0837U30	9ADF32A2E0837U30	9ADA1KA2E0837U30	9ADF3KA2E0837U30
5 (197)	0.4 (2.6)	500	100	10	9ADA42A2E0850U30	9ADF42A2E0850U30	9ADA4KA2E0850U30	9ADF4KA2E0850U30
5 (197)	0.5 (3.2)	620	125	10	9ADA52A2E0862U30	9ADF52A2E0862U30	9ADA5KA2E0862U30	9ADF5KA2E0862U30
5 (197)	0.6 (3.9)	750	150	10	9ADA62A2E0875U30	9ADF62A2E0875U30	9ADA6KA2E0875U30	9ADF6KA2E0875U30
5 (197)	0.7 (4.5)	870	175	10	9ADA72A2E0887U30	9ADF72A2E0887U30	9ADA7KA2E0887U30	9ADF7KA2E0887U30
5 (197)	0.8 (5.2)	990	200	10	9ADA82A2E0899U30	9ADF82A2E0899U30	9ADA8KA2E0899U30	9ADF8KA2E0899U30
10 (394)	0.1 (0.65)	250	25	10	9ADA12A2J0825U30	9ADF12A2J0825U30	9ADA1KA2J0825U30	9ADF1KA2J0825U30
10 (394)	0.2 (1.3)	500	50	10	9ADA22A2J0850U30	9ADF22A2J0850U30	9ADA2KA2J0850U30	9ADF2KA2J0850U30
10 (394)	0.3 (1.9)	750	75	10	9ADA32A3J0875U30	9ADF32A3J0875U30	9ADA3KA3J0875U30	9ADF3KA3J0875U30
10 (394)	0.4 (2.6)	1000	100	10	9ADA42A3J08A0U30	9ADF42A3J08A0U30	9ADA4KA3J08A0U30	9ADF4KA3J08A0U30
10 (394)	0.5 (3.2)	1250	125	10	9ADA52A5J08A3U30	9ADF52A5J08A3U30	9ADA5KA5J08A3U30	9ADF5KA5J08A3U30
10 (394)	0.6 (3.9)	1500	150	10	9ADA62A5J08A5U30	9ADF62A5J08A5U30	9ADA6KA5J08A5U30	9ADF6KA5J08A5U30
10 (394)	0.7 (4.5)	1750	175	10	9ADA72A6J08A8U30	9ADF72A6J08A8U30	9ADA7KA6J08A8U30	9ADF7KA6J08A8U30
10 (394)	0.8 (5.2)	2000	200	10	9ADA82A6J08B0U30	9ADF82A6J08B0U30	9ADA8KA6J08B0U30	9ADF8KA6J08B0U30

- * - 2 x 0.75mm² (AWG18) cord, PVC insulated, length 3m, with UL plug instead of Euro plug, replace U30 by R30 in the part number.
- 3 x 1mm² (AWG16) cord, rubber insulated, length 3m, Euro plug, replace U30 by C30 in the part number
- 3 x 1mm² (AWG16) cord, rubber insulated, length 3m, UL plug, replace U30 by D30 in the part number.
- 2 x 0.75mm² (AWG18) wires, FEP insulated, 500mm long instead of euro plug with 3 meters cord, replace U30 by 450 in the part number
- 3 x 1.5mm² (AWG16) rubber insulated cable, 3 m long, without plug, replace U30 by A30 in the part number
- ** Values above 2000W are not compatible with this series
- *** 2.5mm thickness instead 1.6mm, replace 9ASA by 9ADB or 9ADF by 9ADG in the part number.

Because of permanent improvement of our products, drawings, descriptions, features used on these data sheets are for guidance only and can be modified without prior advice



Flexible silicone rubber heating belts for metal drums



Safety instructions for all industrial silicone rubber belt heaters described in this catalogue section

General conditions

- 1- Read the user manual before any use
- 2- Protect the power supply circuit by a differential circuit breaker of 20mA sensitivity, with rating adapted to the model that must be connected to it.
- 3- This power supply circuit must be carried out by a qualified electrician and according to the local standards in force.
- 4- The earth circuit must be compliant and connected.
- 5- Check that power supply voltage is the same than printed on the heater.
- 6- Don't use silicone rubber heaters with surface power higher than 0.2 W/cm^2 on plastic surfaces.
- 7- The heater must be disconnected during installation or de-installation.
- 8- The heater must be stored in a dry place and protected from rodents and other animals during periods when it is not used.
- 9- Do not cut or punch the surface
- 10- These appliances are not suitable for permanent outdoor use, and must be protected from rain, dust and condensation.
- 11- Silicone heaters are not suitable for prolonged exposure to oils.
- 12- These devices are not suitable for use in flammable or explosive areas.

Additional instructions for heating belts

- 13- Use a silicone heater adapted to the size of the container
- 14- Use the ground terminal located at the cord input in the heater to connect the metal containers to the grounding conductor.
- 15- The heater must be immediately disconnected when the container is empty.
- 16- The heater must be disconnected when filling the container.
- 17- The container must be in communication with the atmospheric pressure to avoid the increase of its internal pressure and its explosion by dilation or boiling of the products which it contains. This setting at atmospheric pressure may for example be performed by unscrewing or removing a plug located in the upper part of the container. The use of a temperature sensor and /or stirrer using this upper orifice for their fastenings must not completely close this orifice.
- 18- Do not operate above rated safety temperature of the product, which is under its boiling temperature. (This temperature must be checked before connecting the device).
- 19- The silicone heater must be in contact with the surface of the container to be heated, without superimposing heating parts. The superposition of two heating parts doubles the surface power and can cause melting of the silicone heater and initiate a fire in the most severe cases.
- 20- Fix tightly the belt on the container with the springs. The belt must not slip by its own weight. Do not extend springs more than 100% of their original length. If the gap between the 2 ends of the belt is too big for the spring, extend the spring with a chain or a cord. If the gap between the 2 ends is too short to have a good grip on the container, it is possible to insert the belt hook between 2 coils of the spring.
- 21- Container surface must be clean and not greasy.
- 22- The silicone rubber band heater must be placed below the level of the fluid, and never on an empty section of the container
- 23- Position the silicone heater so that it is in perfect contact with the largest possible cylindrical surface of the container.
- 24- Never position the silicone heating belts on the hoops of the drums.
- 25- Do not wrap on handles, fittings, taps, legs, plugs, rivets, screws or any surface irregularity.
- 26- Never immerse the belt in liquids or water. It is not immersion proof. If it must be cleaned, disconnect from power supply before cleaning and clean it with soft tissue.
- 27- Do not use on square or rectangular recipients with sharp angles. Angles must have a radius greater than 20mm.

NT3000SPH036A



Silicone rubber heating belts for metal drums, with **surface mounted bimetal thermostat**

Containers material	Maximum temperature	Tightening	Thermostat	Silicone thickness (mm)	Type
Metal only	200°C	Hooks and springs	Creep action adjustable bimetal thermostat	2,5 (3,2)	9AF

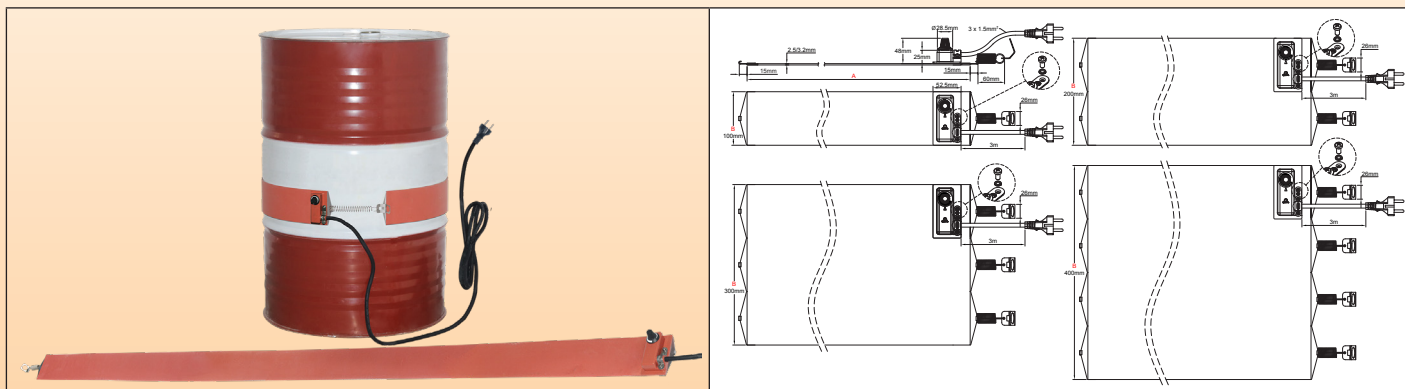

Main features

Silicone belt heaters are made of fiberglass reinforced laminated silicone rubber sheets, vulcanized together through heat and high pressure on both sides of an embedded specially formed heating wire element. Fiberglass-reinforced silicone rubber gives the heater dimensional stability without sacrificing flexibility.

Silicone is used because of its high temperature resistance (Permanent temperature up to 200°C /390°F), high thermal conductivity ($\sim 7 \cdot 10^{-4}$ W/cm.K) and good electrical insulation properties (~ 12 KV/mm).

This series is distinguished by the use of a bimetal thermostat mounted on the surface of the heating part, in a compact and economical design.

Other general particularities of these heaters are:

- Not affected by vibration or flexing,
- Lightweight,
- Comply with UL94-VO (flame retardant) and ROHS,
- Low smoke and low Toxicity,
- Silicone is non-toxic, and moisture and chemical resistant.
- Very thin profile.

Main Applications

Combining high power density with flexibility silicone heating belts are a simple and economical solution for heating metal drums.

They bring and maintain products to the consistency required for their use. Some typical applications examples are:

- Consistency control of paints, oils, greases, fats, molasses, adhesives, plastics, mastics, resins, syrups,
- Freeze protection,
- Maintaining liquid temperatures at 45-65°C (115-150°F) in food industry water purification systems,
- Maintain polyester resin at 20-25°C (70-80°F) for spray and pour equipment.

Technical Features

Clamping on drums: By spring and hook lock-up that allows adjusting the band to the drum diameter; change position to the right place as content levels fluctuate; and also keeps the band tight to the drum surface, providing good thermal contact. Clamping force of each spring is from 1 to 3DaN in the recommended drums diameter range. The spring is equipped with a pull ring for easy installation and removing of the belt.

Length (Dimension A): Designed to be used on standard container diameters. Consult factory if a custom size is requested.

Width (dimension B): 100mm (4"). **Heating belts must always be applied on cylindrical surfaces without hoops or ribs.**

Silicone foil minimum bending radius: 3.2 mm (0.125")

Ingress protection: IP54.

Minimum ambient temperature: -10°C (+15°F)

Voltage: 220-240VAC.

Power tolerance: $\pm 10\%$ at 20°C

Temperature control:

Single pole bimetal thermostat, adjustable from 20°C to 150°C (50~300°F) or from 50 to 200°C (120~390°F). Creep action contact, rating 1500W, 110 and 230V. This low rating limits the possible width of these belts to 100mm

Power density:

- 0.75 w/cm² (4.8 w/inch²), for usual applications.
- 1 w/cm² (6.5 w/inch²) for fast heating applications



Silicone rubber heating belts for metal drums, with **surface mounted bimetal thermostat**

Thickness of the flexible silicone foil: 2.5mm. (Optional 3.2mm, for heavy duty applications requiring strong mechanical strength and reinforced insulation).

Quality control routine tests: Each element is 100% tested for continuity, resistance and insulation. Tests are made according to EN 60335-1 and EN 50106 standards. See technical introduction.

Dielectric Strength: 1750V AC.

Insulation resistance: ≥ 10 Megohms.

Operating temperature:

The temperature controlled by the thermostat is that of the **heating surface**. The temperature of the heated product is generally much lower than that of the surface and depends mainly on the surface power (W/cm^2), the quality of the thermal contact with the container, the viscosity, heat capacity and thermal conductivity of the heated product, the good positioning of the heating belt, the set point value, and room temperature

You can find in the technical introduction examples of the temperatures reached by silicone heating belts. They represent the temperature that may reach the heating belt if it is not correctly installed (for example: poor thermal contact, empty container or improperly temperature controlled).

Connection cable:

Insulated rubber power supply cable, for industrial environments, 3 x 1mm² length 3m, Euro plug. UL plug on request.

Options:

- 3.2mm reinforced thickness.
- Power supply 110/115V
- Power cord with industrial plug 2-pole + earth 16A CEE (IEC60309)
- Surface temperature limiter.
- Grounded mesh wire shield layer
- Power density reduced to 0.2 W/cm^2 (1.3 $w/inch^2$) for plastic containers. In this power density, models in 200 and 300mm width can be made
- Outside thermal insulation by silicone foam layer.

Safety standards:

The heaters have been designed in compliance with EEC Low Voltage Directive (LVD) 2006/95/EC and EMC directive 2004/108/EC. They must be installed in accordance with all local applicable instructions, codes, and regulations.

Main parts numbers in 220/240V, width 100mm, with 3 meters cord and euro plug*

(See the technical introduction for the liquids heating time)

Container Liters (Gallons)	Part number with 30-150°C (50-300°F) thermostat****	Part number with 50-200°C (120-390°F) thermostat***	High and low limits of acceptable diameter (measured at no-ribs or no-ribs place) mm (inch)	A Length	Power density W/cm^2 (W/in^2)	Power**
57~60 (16)	9AFB8E1102855C30	9AFB8W1102855C30	356-373 (14-14.7)	1020 (40.1)	0,75 (4.8)	550
57~60 (16)	9AFBBE1102874C30	9AFBBW1102874C30	356-373 (14-14.7)	1020 (40.1)	1 (6.5)	740
110~120 (30)	9AFB8E1135875C30	9AFB8W1135875C30	463-480 (18.2-18.9)	1350 (53.1)	0,75 (4.8)	750
110~120 (30)	9AFBBE11358A0C30	9AFBBW11358A0C30	463-480 (18.2-18.9)	1350 (53.1)	1 (6.5)	1000
208~210 (55)	9AFB8E1169895C30	9AFB8W1169895C30	571-588 (22.5-23.2)	1690 (66.5)	0.75 (4.8)	950
208~210 (55)	9AFBBE11698A3C30	9AFBBW11698A3C30	571-588 (22.5-23.2)	1690 (66.5)	1 (6.5)	1300

* Cord with UL plug instead of Euro plug, replace C30 by D30 in the Part number.

** Values above 1500W are not compatible with the 6,5A 230V rating of the single pole thermostat.

*** Thermostat knob is not printed in degrees.

**** 3.2mm reinforced thickness, replace FB by FC in the Part number.



Silicone rubber heating belts for metal drums, with surface mounted bulb and capillary thermostat

Containers material	Maximum temperature	Tightening	Thermostat	Silicone thickness (mm)	Type
Metal only	200°C	Hooks and springs	Bulb and capillary	2,5 (3,2)	9AB

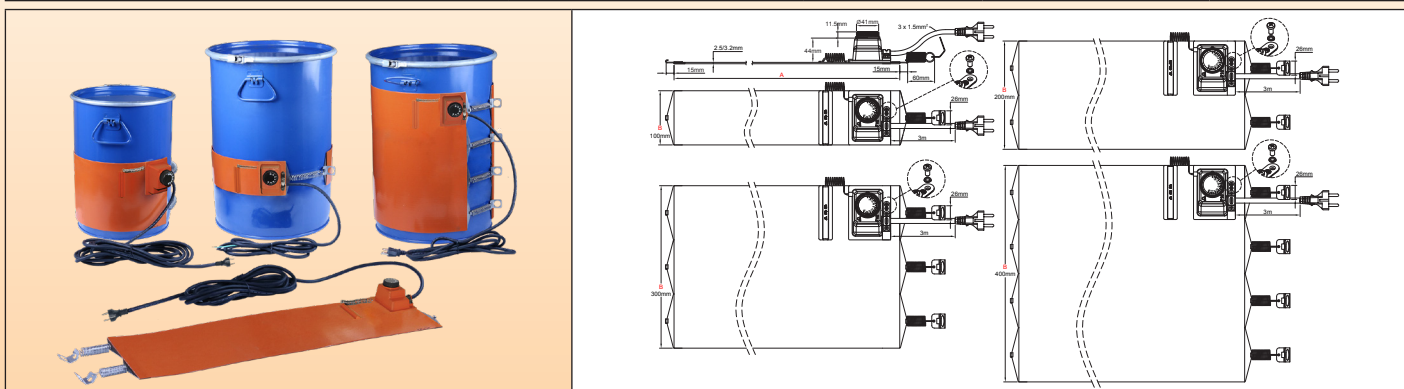

Main features

Silicone belt heaters are made of fiberglass reinforced laminated silicone rubber sheets, vulcanized together through heat and high pressure on both sides of an embedded specially formed heating wire element. Fiberglass-reinforced silicone rubber gives the heater dimensional stability without sacrificing flexibility.

Silicone is used because of its high temperature resistance (Constant temperature up to 200°C (390°F), high thermal conductivity ($\sim 7 \cdot 10^{-4} \text{ W/cm.K}$) and good electrical insulation properties ($\sim 12 \text{ KV/mm}$)

This series is distinguished by the use of a conventional thermostat mounted on the surface of the heating part, in a compact and economical design.

Other general particularities of these heaters are:

- Not affected by vibration or flexing,
- Lightweight,
- Comply with UL94-VO (flame retardant) and ROHS,- Low smoke and low Toxicity,
- Silicone is non-toxic, and moisture and chemical resistant,
- Very thin profile.

Main Applications

Combining high power density with flexibility silicone heating belts are a simple and economical solution for heating metal drums.

They bring and maintain products to the consistency required for their use. Some typical applications examples are:

- Consistency control of paints, oils, greases, fats, molasses, adhesives, plastics, mastics, resins, syrups,
- Freeze protection,
- Maintaining liquid temperatures at 45-65°C (115-150°F) in food industry water purification systems,
- Maintain polyester resin at 20-25°C (70-80°F) for spray and pour equipment.

Technical Features

Clamping on drums: By spring and hook lock-up that allows adjusting the band to the drum diameter; change position to the right place as content levels fluctuate; and also keeps the band tight to the drum surface, providing good thermal contact. Clamping force of each spring is from 1 to 3DaN in the recommended drums diameter range. The spring is equipped with a pull ring for easy installation and removing of the belt.

Length (Dimension A): designed to be used on standard container diameters. Consult factory if a custom size is requested.

Width (dimension B): 100mm (4"), 200mm (8") 300mm (12"), and 400 mm (16"). **Heating belts must always be applied on cylindrical surfaces without hoops or ribs.**

Silicone foil minimum bending radius: 3.2 mm (0.125")

Ingress protection: IP54.

Minimum ambient temperature: -10°C (+15°F)

Voltage: 220-240VAC.

Power tolerance: $\pm 10\%$ at 20°C

Temperature control:

Single pole bulb and capillary thermostat, adjustable from 20°C to 110°C (+50~230°F) or from 50 to 200°C (120-390°F). Rating 16A 230V.

Power density:

- 0.75 w/cm² (4.8 w/inch²), for usual applications.
- 1 w/cm² (6.5 w/inch²) for fast heating applications

Thickness of the flexible silicone foil: 2.5mm. (Optional 3.2mm, for heavy duty applications requiring strong mechanical strength and reinforced insulation).

Quality control routine tests: Each element is 100% tested for continuity, resistance and insulation. Tests are made



Silicone rubber heating belts for metal drums, with surface mounted bulb and capillary thermostat

according to EN 60335-1 and EN 50106 standards. See technical introduction.

Dielectric Strength: 1750V AC.

Insulation resistance: ≥ 10 Megohms.

Operating temperature:

The temperature controlled by the thermostat is that of the heating surface. The temperature of the heated product is generally much lower than that of the surface and depends mainly on the surface power (W/cm^2), the quality of the thermal contact with the container, the viscosity, heat capacity and thermal conductivity of the heated product, the good positioning of the heating belt, the set point value, and room temperature (See technical introduction).

You can find in the technical introduction examples of the temperatures reached by silicone heating belts. They represent the temperature that may reach the heating belt if it is not correctly installed (for example: poor thermal contact, empty container or improperly temperature controlled).

Connection cable:

Insulated rubber power supply cable, for industrial environments, 3 x 1.5mm² length 3m, Euro plug. UL plug on request.

Options:

- 3.2mm reinforced thickness.
- Power supply 110/115V
- Power cord with industrial plug 2-pole + earth 16A CEE (IEC60309)
- Surface temperature limiter.
- Grounded mesh wire shield layer
- Power density reduced to 0.2 W/cm^2 (1.3 $w/inch^2$) for plastic containers
- Outside thermal insulation by silicone foam layer.

Safety standards:

The heaters have been designed in compliance with EEC Low Voltage Directive (LVD) 2006/95/EC and EMC directive 2004/108/EC. They must be installed in accordance with all local applicable instructions, codes, and regulations.

Main parts numbers in 220/240V with 3 meters cord and euro plug*

(See the technical introduction for the liquids heating time)

Belt width B = 100mm						
Container Liters (Gallons)	Part number with 30-110°C (50-230°F) Thermostat	Part number with 50-200°C (120-390°F) Thermostat	High and low limits of acceptable diameter (measured at no-hoops or no-ribs place) mm (inch)	A Length mm (inch)	Power density W/cm^2 (W/in^2)	Power Watts
57~60 (16)	9ABB8G1102855F30	9ABB8L1102855F30	356-373 (14-14.7)	1020 (40.1)	0,75 (4.8)	550
57~60 (16)	9ABBBG1102874F30	9ABBBL1102874F30	356-373 (14-14.7)	1020 (40.1)	1 (6.5)	740
110~120 (30)	9ABB8G1135875F30	9ABB8L1135875F30	463-480 (18.2-18.9)	1350 (53.1)	0,75 (4.8)	750
110~120 (30)	9ABBBG11358A0F30	9ABBBL11358A0F30	463-480 (18.2-18.9)	1350 (53.1)	1 (6.5)	1000
208~210 (55)	9ABB8G1169895F30	9ABB8L1169895F30	571-588 (22.5-23.2)	1690 (66.5)	0.75 (4.8)	950
208~210 (55)	9ABBBG11698A3F30	9ABBBL11698A3F30	571-588 (22.5-23.2)	1690 (66.5)	1 (6.5)	1300
Belt width B = 200mm						
Container Liters (Gallons)	Part number with 30-110°C (50-230°F) Thermostat	Part number with 50-200°C (120-390°F) Thermostat	High and low limits of acceptable diameter (measured at no-hoops or no-ribs place) mm (inch)	A Length mm (inch)	Power density W/cm^2 (W/in^2)	Power Watts
57~60 (16)	9ABB8G21028A3F30	9ABB8L21028A3F30	356-373 (14-14.7)	1020 (40.1)	0,75 (4.8)	1300
57~60 (16)	9ABBBG21028A7F30	9ABBBL21028A7F30	356-373 (14-14.7)	1020 (40.1)	1 (6.5)	1700
110~120 (30)	9ABB8G21358A7F30	9ABB8L21358A7F30	463-480 (18.2-18.9)	1350 (53.1)	0,75 (4.8)	1700
110~120 (30)	9ABBBG21358B3F30	9ABBBL21358B3F30	463-480 (18.2-18.9)	1350 (53.1)	1 (6.5)	2300
208~210 (55)	9ABB8G21698B2F30	9ABB8L21698B2F30	571-588 (22.5-23.2)	1690 (66.5)	0,75 (4.8)	2200
208~210 (55)	9ABBBG21698B9F30	9ABBBL21698B9F30	571-588 (22.5-23.2)	1690 (66.5)	1 (6.5)	2900
Belt width B = 300mm						
Container Liters (Gallons)	Part number with 30-110°C (50-230°F) Thermostat	Part number with 50-200°C (120-390°F) Thermostat	High and low limits of acceptable diameter (measured at no-hoops or no-ribs place) mm (inch)	A Length mm (inch)	Power density W/cm^2 (W/in^2)	Power Watts
57~60 (16)	9ABB8G31028B0F30	9ABB8L31028B0F30	356-373 (14-14.7)	1020 (40.1)	0,75 (4.8)	2000
57~60 (16)	9ABBBG31028B7F30	9ABBBL31028B7F30	356-373 (14-14.7)	1020 (40.1)	1 (6.5)	2700
110~120 (30)	9ABB8G31358B7F30	9ABB8L31358B7F30	463-480 (18.2-18.9)	1350 (53.1)	0,75 (4.8)	2700
110~120 (30)	9ABBBG31358C6F30	9ABBBL31358C6F30	463-480 (18.2-18.9)	1350 (53.1)	1 (6.5)	3600
Belt width B = 400mm						
Container Liters (Gallons)	Part number with 30-110°C (50-230°F) Thermostat	Part number with 50-200°C (120-390°F) Thermostat	High and low limits of acceptable diameter (measured at no-hoops or no-ribs place) mm (inch)	A Length mm (inch)	Power density W/cm^2 (W/in^2)	Power Watts
57~60 (16)	9ABB8G41028B8F30	9ABB8L41028B8F30	356-373 (14-14.7)	1020 (40.1)	0,75 (4.8)	2800**

* Cord with UL plug instead of Euro plug, replace F30 by E30 in the Part number.

** Values above 3600W are not compatible with the 16A 230V rating of the single pole thermostat.

*** Thermostat knob printed in °F instead of °C, replace G by F or L by K in the Part number.

**** 3.2mm reinforced thickness, replace 9ABB by 9ABC in the Part number.

Because of permanent improvement of our products, drawings, descriptions, features used on these data sheets are for guidance only and can be modified without prior advice



Silicone rubber heating belts for metal drums, with remote electronic control, on-off action, 0-120°C or 0-200°C

Containers material	Maximum temperature	Tightening	Thermostat	Silicone thickness (mm)	Type
Metal only	120°C 200°C	Hooks and springs	Remote electronic temperature control, on-off action	2,5 (3,2)	9AC

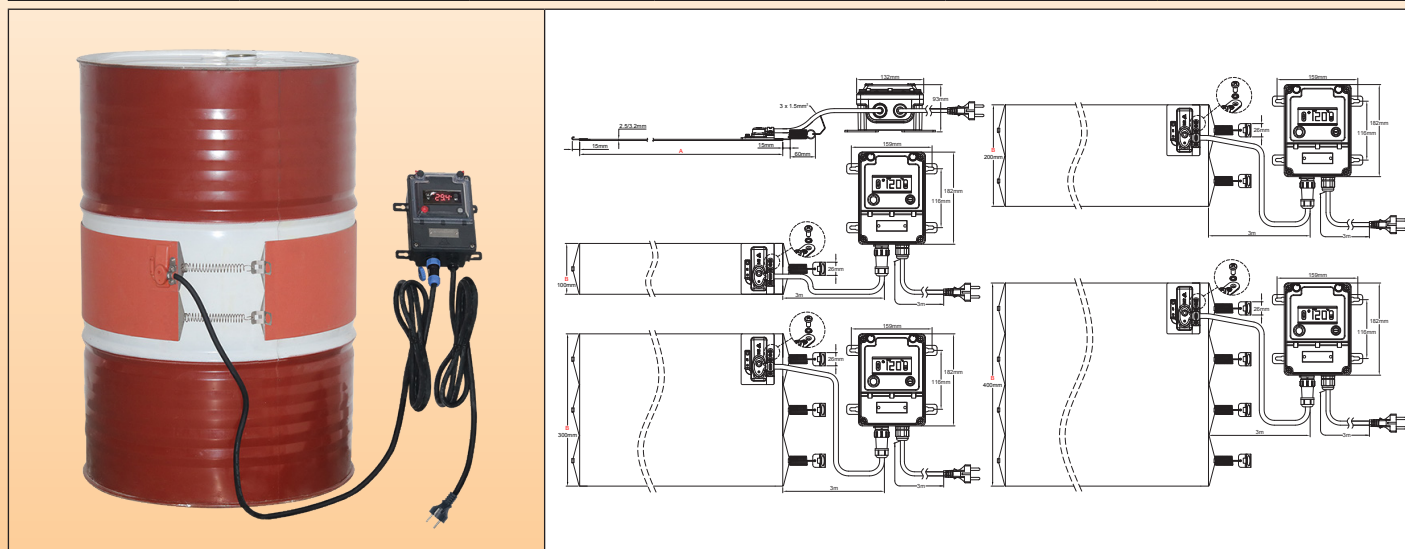

Main features

Silicone rubber belt heaters are made of fiberglass reinforced laminated silicone rubber sheets, vulcanized together through heat and high pressure on both sides of an embedded specially formed heating wire element. Fiberglass-reinforced silicone rubber gives the heater dimensional stability without sacrificing flexibility.

Silicone is used because of its high temperature resistance (Constant temperature up to 200°C (390°F), high thermal conductivity ($\sim 7 \cdot 10^{-4}$ W/cm.K) and good electrical insulation properties (~ 12 KV/mm)

This series is distinguished by the use of a remote electronic control system, on-off action, with digital display of the measured value, connection by waterproof connector for easy disconnection of the heater, and IP65 ingress protection class for the whole assembly. This allows its use in most of industrial applications.

Other general particularities of these flexible silicone heaters are:

- Not affected by vibration or flexing,
- Lightweight,
- Comply with UL94-VO (flame retardant) and ROHS,
- Low smoke and low Toxicity,
- Silicone is non-toxic, and moisture and chemical resistant
- Very thin profile

Main Applications

Combining high power density with flexibility silicone heating belts are a simple and economical solution for heating metal drums.

They bring and maintain products to the consistency required for their use. Some typical applications examples are:

- Consistency control of paints, oils, greases, fats, molasses, adhesives, plastics, mastics, resins, syrups,
- Freeze protection,
- Maintaining liquid temperatures at 45-65°C (115-150°F) in food industry water purification systems,
- Maintain polyester resin at 20-25°C (70-80°F) for spray and pour equipment.

Technical Features

Clamping on drums: By spring and hook lock-up that allows adjusting the band to the drum diameter; change position to the right place as content levels fluctuate; and also keeps the band tight to the drum surface, providing good thermal contact. Clamping force of each spring is from 1 to 3DaN in the recommended drums diameter range. The spring is equipped with a pull ring for easy installation and removing of the belt.

Length (Dimension A): designed to be used on standard container diameters. Consult factory if a custom size is requested.

Width (dimension B): 100mm (4"), 200mm (8") 300mm (12"), and 400 mm (16"). **Heating belts must always be applied on cylindrical surfaces without hoops or ribs.**

Silicone foil minimum bending radius: 3.2 mm (0.125")

Ingress protection: IP65.

Minimum ambient temperature: -10°C (+15°F)



Silicone rubber heating belts for metal drums, with remote electronic control, on-off action, 0-120°C or 0-200°C

Voltage: 220-240VAC.

Power tolerance: ±10% at 20°C

Temperature control:

By electronic controller with digital display, On-Off action, set point adjustment range up to 120°C (NTC sensor), or 200°C (Pt100 sensor), relay output, located in an independent **waterproof** housing, **designed for wall mounting**. It is connected to the flexible silicone rubber heater by a cable equipped with a 5-pin **waterproof quick connector**, facilitating the connection and disconnection with the heater. It controls the temperature by means of a probe placed under a silicone boot on the outer surface of the heater.

Rating 16A 230V.

The setting of this temperature controller is extremely simple.

Power density:

- 0.75 w/cm² (4.8 w/inch²), for usual applications.

- 1 w/cm² (6.5 w/inch²) for fast heating applications

Thickness of the flexible silicone foil: 2.5mm. (Optional 3.2mm, for heavy duty applications requiring strong mechanical strength and reinforced insulation).

Quality control routine tests: Each element is 100% tested for continuity, resistance and insulation. Tests are made according to EN 60335-1 and EN 50106 standards. See technical introduction.

Dielectric Strength: 1750V AC.

Insulation resistance: ≥ 10 Megohms.

Operating temperature:

The temperature measured by the electronic controller is that of the heating surface. The temperature of the heated product is generally much lower than that of the surface and depends mainly on the surface power (W/cm²), the quality of the thermal contact with the container, the viscosity, heat capacity and thermal conductivity of the heated product, the good positioning of the heating belt, the set point value, and room temperature (See technical introduction).

You can find in the technical introduction examples of the temperatures reached by silicone heating belts. They represent the temperature that may reach the heating belt if it is not correctly installed (for example: poor thermal contact, empty container or improperly temperature controlled).

Connection cable:

Insulated rubber power supply cable, for industrial environments, 3 x 1.5mm² length 3m, Euro plug. UL plug on request.

Options:

- 3.2mm reinforced thickness.

- Power supply 110/115V.

- Power cord with industrial plug 2-pole + earth 16A CEE (IEC60309)

- Surface temperature limiter.

- Grounded mesh wire layer.

- **Power density reduced to 0.2 W/cm² (1.3 w/inch²) for plastic containers.**

- Outside thermal insulation by silicone foam layer.

Safety standards:

The heaters have been designed in compliance with EEC Low Voltage Directive (LVD) 2006/95/EC and EMC directive 2004/108/EC. They must be installed in accordance with all local applicable instructions, codes, and regulations.

Main parts numbers in 220/240V with 3 meters cords and euro plug*

(See the technical introduction for the liquids heating time)

Belt width B = 100mm						
Container Liters (Gallons)	Part number with temperature controller adjustable up to 120°C (250°F)	Part number with temperature controller adjustable up to 200°C (390°F)	High and low limits of acceptable diameter (measured at no-hoops or no-ribs place) mm (inch)	A Length mm (inch)	Power density W/cm ² (W/in ²)	Power Watts
57~60 (16)	9ACB8A1102855F30	9ACB8B1102855F30	356-373 (14-14.7)	1020 (40.1)	0,75 (4.8)	550
57~60 (16)	9ACBBA1102874F30	9ACBBB1102874F30	356-373 (14-14.7)	1020 (40.1)	1 (6.5)	740
110~120 (30)	9ACB8A1135875F30	9ACB8B1135875F30	463-480 (18.2-18.9)	1350 (53.1)	0,75 (4.8)	750
110~120 (30)	9ACBBA11358A0F30	9ACBBB11358A0F30	463-480 (18.2-18.9)	1350 (53.1)	1 (6.5)	1000
208~210 (55)	9ACB8A1169895F30	9ACB8B1169895F30	571-588 (22.5-23.2)	1690 (66.5)	0.75 (4.8)	950
208~210 (55)	9ACBBA11698A3F30	9ACBBB11698A3F30	571-588 (22.5-23.2)	1690 (66.5)	1 (6.5)	1300
Belt width B = 200mm						
Container Liters (Gallons)	Part number with temperature controller adjustable up to 120°C (250°F)	Part number with temperature controller adjustable up to 200°C (390°F)	High and low limits of acceptable diameter (measured at no-hoops or no-ribs place) mm (inch)	A Length mm (inch)	Power density W/cm ² (W/in ²)	Power Watts
57~60 (16)	9ACB8A21028A3F30	9ACB8B21028A3F30	356-373 (14-14.7)	1020 (40.1)	0,75 (4.8)	1300
57~60 (16)	9ACBBA21028A7F30	9ACBBB21028A7F30	356-373 (14-14.7)	1020 (40.1)	1 (6.5)	1700
110~120 (30)	9ACB8A21358A7F30	9ACB8B21358A7F30	463-480 (18.2-18.9)	1350 (53.1)	0,75 (4.8)	1700
110~120 (30)	9ACBBA21358B3F30	9ACBBB21358B3F30	463-480 (18.2-18.9)	1350 (53.1)	1 (6.5)	2300
208~210 (55)	9ACB8A21698B2F30	9ACB8B21698B2F30	571-588 (22.5-23.2)	1690 (66.5)	0,75 (4.8)	2200
208~210 (55)	9ACBBA21698B9F30	9ACBBB21698B9F30	571-588 (22.5-23.2)	1690 (66.5)	1 (6.5)	2900

Because of permanent improvement of our products, drawings, descriptions, features used on these data sheets are for guidance only and can be modified without prior advice



Silicone rubber heating belts for metal drums, with **remote electronic control, on-off action, 0-120°C or 0-200°C**

Because of permanent improvement of our products, drawings, descriptions, features used on these data sheets are for guidance only and can be modified without prior advice

Belt width B = 300mm						
Container Liters (Gallons)	Part number with temperature controller adjustable up to 120°C (250°F)	Part number with temperature controller adjustable up to 200°C (390°F)	High and low limits of acceptable diameter (measured at no-hoops or no-ribs place) mm (inch)	A Length mm (inch)	Power density W/cm ² (W/in ²)	Power Watts
57~60 (16)	9ACB8A31028B0F30	9ACB8B31028B0F30	356-373 (14-14.7)	1020 (40.1)	0,75 (4.8)	2000
57~60 (16)	9ACBBA31028B7F30	9ACBBB31028B7F30	356-373 (14-14.7)	1020 (40.1)	1 (6.5)	2700
110~120 (30)	9ACB8A31358B7F30	9ACB8B31358B7F30	463-480 (18.2-18.9)	1350 (53.1)	0,75 (4.8)	2700
110~120 (30)	9ACBBA31358C6F30	9ACBBB31358C6F30	463-480 (18.2-18.9)	1350 (53.1)	1 (6.5)	3600**
Belt width B = 400mm						
Container Liters (Gallons)	Part number with temperature controller adjustable up to 120°C (250°F)	Part number with temperature controller adjustable up to 200°C (390°F)	High and low limits of acceptable diameter (measured at no-hoops or no-ribs place) mm (inch)	A Length mm (inch)	Power density W/cm ² (W/in ²)	Power Watts
57~60 (16)	9ACB8A41028B8F30	9ACB8B41028B8F30	356-373 (14-14.7)	1020 (40.1)	0,75 (4.8)	2800**

* Cord with UL plug instead of Euro plug, replace F30 by E30 in the Part number.

** Values above 3600W are not compatible with the 16A 230V rating of the electronic controller.

*** 3.2mm reinforced thickness, replace 9ACB by 9ACC in the Part number.



Silicone rubber heating belts for metal drums, with remote electronic control, PID action, 0-200°C

Containers material	Maximum temperature	Tightening	Thermostat	Silicone thickness (mm)	Type
Metal only	200°C	Hooks and springs	Remote electronic temperature control, double display, PID action, SSR output	2,5 (3,2)	9AQ

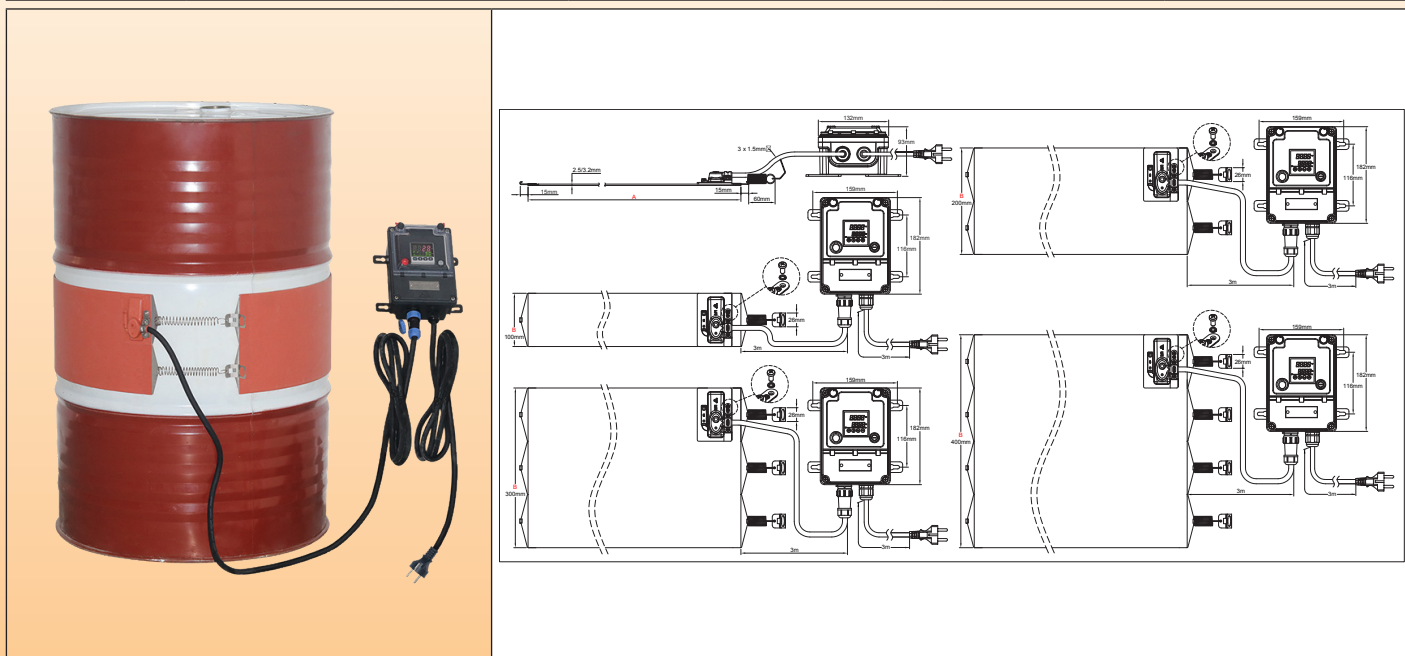

Main features

Silicone rubber belt heaters are made of fiberglass reinforced laminated silicone rubber sheets, vulcanized together through heat and high pressure on both sides of an embedded specially formed heating wire element. Fiberglass-reinforced silicone rubber gives the heater dimensional stability without sacrificing flexibility.

Silicone is used because of its high temperature resistance (Constant temperature up to 200°C (390°F), high thermal conductivity ($\sim 7 \cdot 10^{-4}$ W/cm.K) and good electrical insulation properties (~ 12 KV/mm)

This series is distinguished by the use of a remote electronic control system, on-off action, with digital display of the measured value, connection by waterproof connector for easy disconnection of the heater, and IP65 ingress protection class for the whole assembly. This allows its use in industrial applications when a precise and without overheat temperature control is requested

Other general particularities of these flexible silicone heaters are:

- Not affected by vibration or flexing,
- Lightweight,
- Comply with UL94-VO (flame retardant) and ROHS,
- Low smoke and low Toxicity,
- Silicone is non-toxic, and moisture and chemical resistant.
- Very thin profile.

Main Applications

Combining high power density with flexibility silicone heating belts are a simple and economical solution for heating metal drums.

They bring and maintain products to the consistency required for their use. Some typical applications examples are:

- Consistency control of paints, oils, greases, fats, molasses, adhesives, plastics, mastics, resins, syrups,
- Freeze protection,
- Maintaining liquid temperatures at 45-65°C (115-150°F) in food industry water purification systems,
- Maintain polyester resin at 20-25°C (70-80°F) for spray and pour equipment.

Technical Features

Clamping on drums: By spring and hook lock-up that allows adjusting the band to the drum diameter; change position to the right place as content levels fluctuate; and also keeps the band tight to the drum surface, providing good thermal contact. Clamping force of each spring is from 1 to 3DaN in the recommended drums diameter range. The spring is equipped with a pull ring for easy installation and removing of the belt.

Length (Dimension A): designed to be used on standard container diameters. Consult factory if a custom size is requested.

Width (dimension B): 100mm (4"), 200mm (8") 300mm (12"), and 400 mm (16"). Heating belts must always be applied on cylindrical surfaces without hoops or ribs.

Because of permanent improvement of our products, drawings, descriptions, features used on these data sheets are for guidance only and can be modified without prior advice



Silicone rubber heating belts for metal drums, with remote electronic control, PID action, 0-200°C

Silicone foil minimum bending radius: 3.2 mm (0.125")

Ingress protection: IP65.

Minimum ambient temperature: -10°C (+15°F)

Voltage: 220-240VAC.

Power tolerance: ±10% at 20°C

Temperature control: Controller with double display, of process value and of set-point, located in an independent **waterproof** housing, **designed for wall mounting**. It is connected to the flexible silicone rubber heater by a cable equipped with a 5-pin **waterproof quick connector**, facilitating the connection and disconnection with the heater. It controls the temperature by means of a probe placed under a silicone boot on the outer surface of the heater.

Action: PID with automatic parameters adjustment by auto-tune function.

Sensor input: Pt100

Power output: solid state relay, maximum 16A 230V.

Alarm: 3A 230V relay.

Display: 4 digits display configurable in °C or °F

Power supply: AC 220-230V 50-60Hz.

Accuracy: ±1°C (±2°F) or 0.3% ES± one digit.

Self-testing: open sensor circuit.

Ambient temperature: -10 to 60°C, 20 to 85% relative humidity, non-condensing.

Temperature display range: Configurable

Resolution: 0.1°

Read instruction manual before the setting of this temperature controller.

Power density:

- 0.75 w/cm² (4.8 w/inch²), for usual applications.

- 1 w/cm² (6.5 w/inch²) for fast heating applications

Thickness of the flexible silicone foil: 2.5mm. (Optional 3.2mm, for heavy duty applications requiring strong mechanical strength and reinforced insulation).

Quality control routine tests: Each element is 100% tested for continuity, resistance and insulation. Tests are made according to EN 60335-1 and EN 50106 standards. See technical introduction.

Dielectric Strength: 1750V AC.

Insulation resistance: ≥ 10 Megohms.

Operating temperature:

The temperature measured by the electronic controller is that of the heating surface. The temperature of the heated product is generally much lower than that of the surface and depends mainly on the surface power (W/cm²), the quality of the thermal contact with the container, the viscosity, heat capacity and thermal conductivity of the heated product, the good positioning of the heating belt, the set point value, and room temperature (See technical introduction).

You can find in the technical introduction examples of the temperatures reached by silicone heating belts. They represent the temperature that may reach the heating belt if it is not correctly installed (for example: poor thermal contact, empty container or improperly temperature controlled).

Connection cable:

Insulated rubber power supply cable, for industrial environments, 3 x 1.5mm² length 3m, Euro plug. UL plug on request.

Options:

- Power density reduced to 0.2 W/cm² (1.3 w/inch²) for plastic containers

- 3.2mm reinforced thickness.

- Power supply 110/115V

- Power cord with industrial plug 2-pole + earth 16A CEE (IEC60309)

- Surface temperature limiter.

- Grounded metal mesh layer.

- Outside thermal insulation by silicone foam layer

Safety standards:

The heaters have been designed in compliance with EEC Low Voltage Directive (LVD) 2006/95/EC and EMC directive 2004/108/EC. They must be installed in accordance with all local applicable instructions, codes, and regulations.

Main parts numbers in 220/240V with 3 meters cords and euro plug*

(See the technical introduction for the liquids heating time)

Belt width B = 100mm					
Container Liters (Gallons)	Part number with temperature controller adjustable up to 200°C (390°F)	High and low limits of acceptable diameter (measured at no-hoops or no-ribs place) mm (inch)	A Length mm (inch)	Power density W/cm ² (W/in ²)	Power Watts
57~60 (16)	9AQB8C1102855F30	356-373 (14-14.7)	1020 (40.1)	0,75 (4.8)	550
57~60 (16)	9AQB8C1102874F30	356-373 (14-14.7)	1020 (40.1)	1 (6.5)	740
110~120 (30)	9AQB8C1135875F30	463-480 (18.2-18.9)	1350 (53.1)	0,75 (4.8)	750
110~120 (30)	9AQB8C11358A0F30	463-480 (18.2-18.9)	1350 (53.1)	1 (6.5)	1000
208~210 (55)	9AQB8C1169895F30	571-588 (22.5-23.2)	1690 (66.5)	0.75 (4.8)	950
208~210 (55)	9AQB8C11698A3F30	571-588 (22.5-23.2)	1690 (66.5)	1 (6.5)	1300



Contact us

Web: www.ultimheat.com

Cat25-2-5-11

Silicone rubber heating belts for metal drums, with **remote electronic control, PID action, 0-200°C**

Belt width B = 200mm					
Container Liters (Gallons)	Part number with temperature controller adjustable up to 200°C (390°F)	High and low limits of acceptable diameter (measured at no-hoops or no-ribs place) mm (inch)	A Length	Power density W/cm ² (W/in ²)	Power Watts
57~60 (16)	9AQB8C21028A3F30	356-373 (14-14.7)	1020 (40.1)	0,75 (4.8)	1300
57~60 (16)	9AQB8C21028A7F30	356-373 (14-14.7)	1020 (40.1)	1 (6.5)	1700
110~120 (30)	9AQB8C21358A7F30	463-480 (18.2-18.9)	1350 (53.1)	0,75 (4.8)	1700
110~120 (30)	9AQB8C21358B3F30	463-480 (18.2-18.9)	1350 (53.1)	1 (6.5)	2300
208~210 (55)	9AQB8C21698B2F30	571-588 (22.5-23.2)	1690 (66.5)	0,75 (4.8)	2200
208~210 (55)	9AQB8C21698B9F30	571-588 (22.5-23.2)	1690 (66.5)	1 (6.5)	2900
Belt width B = 300mm					
Container Liters (Gallons)	Part number with temperature controller adjustable up to 200°C (390°F)	High and low limits of acceptable diameter (measured at no-hoops or no-ribs place) mm (inch)	A Length mm (inch)	Power density W/cm ² (W/in ²)	Power Watts
57~60 (16)	9AQB8C31028B0F30	356-373 (14-14.7)	1020 (40.1)	0,75 (4.8)	2000
57~60 (16)	9AQB8C31028B7F30	356-373 (14-14.7)	1020 (40.1)	1 (6.5)	2700
110~120 (30)	9AQB8C31358B7F30	463-480 (18.2-18.9)	1350 (53.1)	0,75 (4.8)	2700
110~120 (30)	9AQB8C31358C6F30	463-480 (18.2-18.9)	1350 (53.1)	1 (6.5)	3600**
Belt width B = 400mm					
Container Liters (Gallons)	Part number with temperature controller adjustable up to 200°C (390°F)	High and low limits of acceptable diameter (measured at no-hoops or no-ribs place) mm (inch)	A Length mm (inch)	Power density W/cm ² (W/in ²)	Power Watts
57~60 (16)	9AQB8C41028B8F30	356-373 (14-14.7)	1020 (40.1)	0,75 (4.8)	2800**

* Cord with UL plug instead of Euro plug, replace F30 by E30 in the Part number.

** Values above 3600W are not compatible with the 16A 230V rating of the electronic controller.

*** 3.2mm reinforced thickness, replace 9AQB by 9AQC in the Part number.

Because of permanent improvement of our products, drawings, descriptions, features used on these data sheets are for guidance only and can be modified without prior advice



Flexible silicone rubber heating pads



Safety instructions for all industrial flat silicone rubber heaters described in this catalogue section



- Read the user manual before any use
- Protect the power supply circuit by a differential circuit breaker of 20mA sensitivity, with rating adapted to the model that must be connected to it.
- This supply circuit must be carried out by a qualified electrician and according to the local standards in force.
- The earth circuit must be compliant and connected.
- Don't use silicone rubber heaters with surface power higher than 0.2 W/cm² on plastic material.
- The heater must be disconnected when not used
- The heater must be disconnected during installation or de-installation.
- The heater must be stored in a dry place and protected from rodents and other animals during periods when it is not used.
- In some applications it may be mandatory to connect the heated surface directly to a grounding conductor.
- Do not cut or punch the surface
- These appliances are not suitable for permanent outdoor use, and, upon their ingress protection rating (IP), must be protected from rain, dust and condensation.
- Do not operate above the rated safety temperature
- The silicone heater must be in perfect contact with the surface to be heated, without superimposing heating parts. The superposition of two heating parts doubles the surface power and can cause melting of the silicone heater and initiate a fire in the most severe cases.
- Silicone heaters with an adhesive face have their maximum safety temperature limited by the adhesive layer used.
- Silicone heaters are not suitable for prolonged exposure to oils.
- These devices are not suitable for use in flammable or explosive areas.

NT3000SPH039A

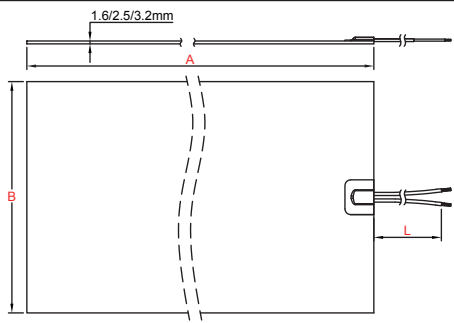

Flexible silicone rubber heating pads, **without temperature control**

Temperature sensors	Maximum temperature	Mounting	Temperature control	Silicone thickness (mm)	Type
Optional	200°C	Optional adhesive face	Without	1.6 2.5 3.2	9AR

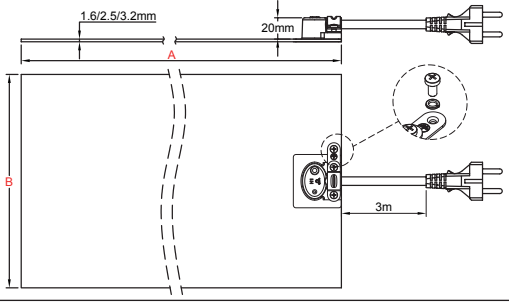
	
Wires output	Wires output
	
Cord output	Cord output

Main features

Flexible silicone rubber heaters are made of fiberglass reinforced laminated silicone rubber sheets, vulcanized together through heat and high pressure on both sides of an embedded specially formed heating wire element. Fiberglass-reinforced silicone rubber gives the heater dimensional stability without sacrificing flexibility.

Silicone is used because of its high temperature resistance (permanent temperature up to 200°C (390°F), high thermal conductivity (~7 10⁻⁴W/cm.K) and good electrical insulation properties (~12KV/mm)

This compact and economical series is intended to be integrated into a device. The temperature control is carried out by the integrator. Sensors or temperature limiters can be incorporated into the heating surface. Other general particularities of these heaters are:

- Not affected by vibration or flexing,
- Lightweight,
- Comply with UL94-VO (flame retardant) and ROHS,
- Low smoke and low toxicity,
- Silicone is non-toxic, and moisture and chemical resistant.
- Very thin profile.

Main applications

Combining high surface power and flexibility, flexible silicone heating elements are a simple and economical solution for heating surfaces. They are light, thin, heat quickly and evenly because they are in direct contact with the surface to be heated. Their construction is rugged, and they do not change dimensions during heating. They can be mounted on flat or cylindrical surfaces. Their bonding to the surfaces can be made by vulcanization, room temperature vulcanizable resin (RTV), or by application of a pressure-sensitive adhesive (PSA).

Some typical examples of applications are:

Autoclaves, Surveillance cameras, Mold heaters for polymerization of resins, Poultry incubators, Diesel fuel filters, Defrost, Cash Machines, Laboratory Equipment, Gyroscopes, Laminators, Heated Mirrors, Animal Feeders, Photocopiers, Food heating Trays, Heat Presses, Battery Heaters, Tanks for liquids, etc.

They can be made in multiple shapes, receive cutouts or holes. They can receive temperature sensors, temperature limiters, thermal fuses and thermostats.

Technical Features

Mounting: By a pressing system on the surface made by the user or by bonding with a room temperature vulcanizing silicone resin (RTV), or by adhesive.

Because of permanent improvement of our products, drawings, descriptions, features used on these data sheets are for guidance only and can be modified without prior advice



Flexible silicone rubber heating pads, **without temperature control**

Length (Dimension A): Upon customer request.
Width (dimension B): Upon customer request.
Silicone foil minimum bending radius: 3.2 mm (0.125)
Ingress protection: IP65.
Minimum ambient temperature: -10° C (+15° F)
Voltage: 220-240VAC.
Power tolerance: ±10% at 20°C
Temperature control: none

Power density:
 - 0.2 w/cm² (1.3W/in²) for plastic materials.
 - 0.75 w/cm² (4.8 w/inch²), for usual applications.
 - 1 w/cm² (6.5 w/inch²) for fast heating applications.
 Other values on request.

Thickness of the flexible silicone foil:
 - 1.6mm for light application and small surfaces
 - 2.5mm for usual industrial applications
 - 3.2mm, for heavy duty applications requiring strong mechanical strength and reinforced insulation.

Quality control routine tests: Each element is 100% tested for continuity, resistance and insulation. Tests are made according to EN 60335-1 and EN 50106 standards. See technical introduction.

Dielectric Strength: 1750V AC.
Insulation resistance: ≥ 10 Megohms.

Operating temperature:
 See in the technical introduction examples of the temperatures reached by silicone heating belts. They represent the temperature that may reach the silicone heater if it is not correctly installed.

Connection cable:
 There are 2 types available in standard
 - FEP insulated wires, AWG 18 (0.8mm²) for power up to 1800W in 230V. Wire gauge is increased for higher ratings.
 - Insulated rubber power supply cable, for industrial environments, 3 x 1.5mm² (AWH15), length 3m, Euro plug. UL plug on request.

Options:
 - Customer design shape, with or without holes
 - Power supply 110/115V
 - Power cord with industrial plug 2-pole + earth 16A CEE (IEC60309).
 - Surface mounted temperature limiter.
 - Surface mounted temperature sensor (Pt100, NTC, thermocouple)
 - Grounded mesh wire shield layer
 - Silicone foam insulation layer vulcanized on the external surface

Safety standards:

The heaters have been designed in compliance with EEC Low Voltage Directive (LVD) 2006/95/EC and EMC directive 2004/108/EC. They must be installed in accordance with all local applicable instructions, codes, and regulations.

Main parts numbers in 220/240V, with 0.75W/cm² (4.8 w/inch²), surface power*

These references are incomplete. Full part number are issued when order is received. These heaters are manufactured only on order. Specify length and width						
Connection	1.6mm thickness without adhesive	2.5mm thickness without adhesive	3.2mm thickness without adhesive	1.6mm thickness with adhesive	2.5mm thickness with adhesive	3.2mm thickness with adhesive
2 FEP insulated conductors, AWG18, (0.8mm ²) length 500mm	9ARA80---8--450	9ARB80---8--450	9ARC80---8--450	9ARF80---8--450	9ARG80---8--450	9ARH80---8--450
3x1mm ² cable rubber insulation, length 3m, euro plug **	9ARA80---8--C30	9ARB80---8--C30	9ARC80---8--C30	9ARF80---8--C30	9ARG80---8--C30	9ARH80---8--C30

NB: the characters “-” in the part numbers are updated after selection of the length and the width of the silicone rubber heater

* - For surface load 0.2 w/cm² (1.3W/in²), replace 80 with 20 in the reference.

- For surface load 1 w/cm² (6.5 w/in²), replace 80 with B0 in the reference.

** For UL plug instead of Euro plug, replace C3 with D3 in the part number.

Because of permanent improvement of our products, drawings, descriptions, features used on these data sheets are for guidance only and can be modified without prior advice



Flexible silicone rubber heating pads, with surface mounted adjustable thermostat

Temperature limiter	Maximum temperature	Mounting	Temperature control	Silicone thickness (mm)	Type
Optional	200°C	Optional adhesive face	Adjustable thermostat	1.6 2.5 3.2	9AE

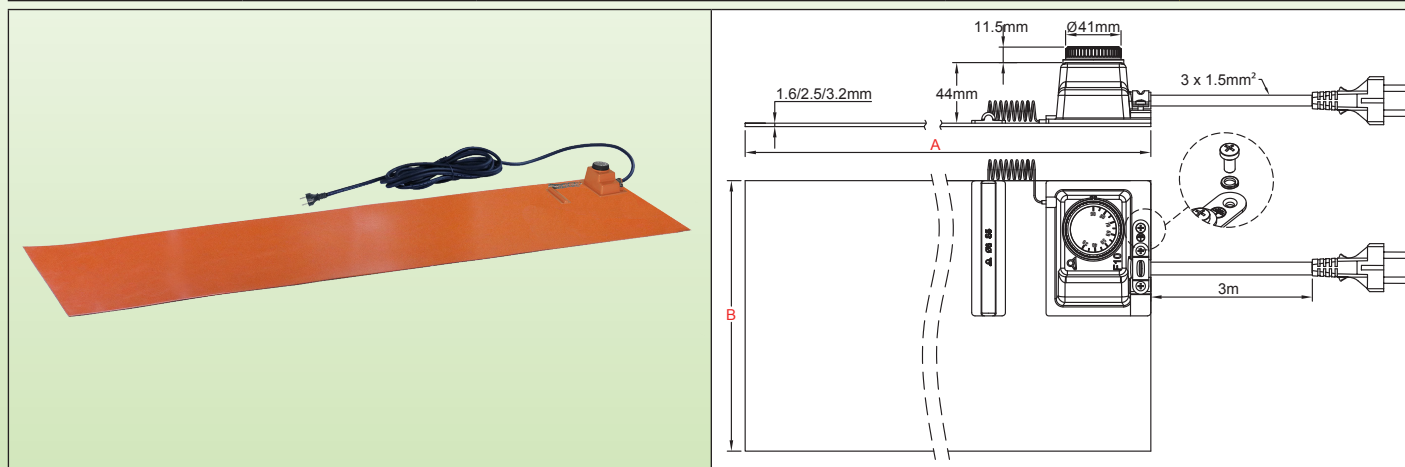

Main features

Flat and flexible silicone rubber heaters are made of fiberglass reinforced laminated silicone rubber sheets, vulcanized together through heat and high pressure on both sides of an embedded specially formed heating wire element. Fiberglass-reinforced silicone rubber gives the heater dimensional stability without sacrificing flexibility. Silicone is used because of its high temperature resistance (Permanent temperature up to 200°C (390°F), high thermal conductivity ($\sim 7 \cdot 10^{-4} \text{ W/cm.K}$) and good electrical insulation properties ($\sim 12 \text{ KV/mm}$)

This series is distinguished by the use of a conventional thermostat mounted on the surface of the heating part, in a compact and economical design.

Other general particularities of these heaters are:

- Not affected by vibration or flexing,
- Lightweight,
- Comply with UL94-VO (flame retardant) and ROHS,
- Low smoke and low Toxicity,
- Silicone is non-toxic, and moisture and chemical resistant.
- Very thin profile.

Main applications

Combining high surface power and flexibility, flexible silicone heating elements are a simple and economical solution for heating surfaces. They are light, thin, heat quickly and evenly because they are in direct contact with the surface to be heated. Their construction is rugged, and they do not change dimensions during heating. They can be mounted on flat or cylindrical surfaces. Their bonding to the surfaces can be made by vulcanization, room temperature vulcanizable resin (RTV), or by application of a pressure-sensitive adhesive (PSA).

Some typical examples of applications are:

Autoclaves, Surveillance cameras, Mold heaters for polymerization of resins, Poultry incubators, Diesel fuel filters, Defrost, Cash Machines, Laboratory Equipment, Gyroscopes, Laminators, Heated Mirrors, Animal Feeders, Photocopiers, Food heating Trays, Heat Presses, Battery Heaters, Tanks for liquids, etc.

They can be made in multiple shapes, receive cutouts or holes. They can receive temperature sensors, temperature limiters, thermal fuses and thermostats.

Technical Features

Mounting: By a pressing system on the surface made by the user or by bonding with a room temperature vulcanizing silicone resin (RTV), or by adhesive.

Length (Dimension A): Upon customer request.

Width (dimension B): Upon customer request (minimum 100mm).

Silicone foil minimum bending radius: 3.2 mm (0.125)

Ingress protection: IP65.

Minimum ambient temperature: -10°C (+15°F)

Voltage: 220-240VAC.

Power tolerance: $\pm 10\%$ at 20°C

Temperature control:

Single pole bulb and capillary thermostat, adjustable from 20°C to 110°C (+50~230°F) or from 50 to 200°C (120-390°F). Rating 16A 230V.

Because of permanent improvement of our products, drawings, descriptions, features used on these data sheets are for guidance only and can be modified without prior advice



[Contact us](#)

Web: www.ultimheat.com

Cat25-2-6-5

Flexible silicone rubber heating pads, with surface mounted adjustable thermostat

Power density:

- 0.2 w/cm² (1.3W/in²) for plastic materials
 - 0.75 w/cm² (4.8 w/inch²), for usual applications.
 - 1 w/cm² (6.5 w/inch²) for fast heating applications
- Other values on request.

Thickness of the flexible silicone foil:

- 1.6mm for light application and small surfaces
- 2.5mm for usual industrial applications
- 3.2mm, for heavy duty applications requiring strong mechanical strength and reinforced insulation.

Quality control routine tests: Each element is 100% tested for continuity, resistance and insulation. Tests are made according to EN 60335-1 and EN 50106 standards. See technical introduction.

Dielectric Strength: 1750V AC.

Insulation resistance: ≥ 10 Megohms.

Operating temperature:

See in the technical introduction examples of the temperatures reached by flexible silicone heaters. They represent the temperature that may reach the heating belt if it is not correctly installed.

Connection cable:

Insulated rubber power supply cable, for industrial environments, 3 x 1.5mm² (3xAWG15) length 3m, Euro plug. UL plug on request.

Options:

- Customer design shape, with or without holes
- Power supply 110/115V
- Power cord with industrial plug 2-pole + earth 16A CEE (IEC60309).
- Surface mounted temperature limiter.
- Surface mounted temperature sensor (Pt100, NTC, thermocouple)
- Grounded mesh wire shield layer
- Silicone foam insulation layer vulcanized on the external surface

Safety standards:

The heaters have been designed in compliance with EEC Low Voltage Directive (LVD) 2006/95/EC and EMC directive 2004/108/EC. They must be installed in accordance with all local applicable instructions, codes, and regulations.

Main parts numbers in 220/240V, with 0.75W/cm² (4.8 w/inch²), surface power*

These references are incomplete. Full part number are issued when order is received. These heaters are manufactured only on order. Specify length and width

Thermostat setting range	1.6mm thickness without adhesive	2.5mm thickness without adhesive	3.2mm thickness without adhesive	1.6mm thickness with adhesive	2.5mm thickness with adhesive	3.2mm thickness with adhesive
20~110°C*** (+50~230°F)	9AEA8G----8--F30	9AEB8G----8--F30	9AEC8G----8--F30	9AEF8G----8--F30	9AEG8G----8--F30	9AEH8G----8--F30
50 ~ 200°C*** (120~390°F)	9AEA8L----8--F30	9AEB8L----8--F30	9AEC8L----8--F30	9AEF8L----8--F30	9AEG8L----8--F30	9AEH8L----8--F30

NB: the characters "-" in the part numbers are updated after selection of the length and the width of the silicone rubber heater

* - For surface load 0.2 w/cm² (1.3W/in²), replace 8G with 2G or 8L with 2L in the reference.

- For surface load 1 w/cm² (6.5 w/in²), replace 8G with BG or 8L with BL in the reference.

** For UL plug instead of Euro plug, replace F3 with E3 in the part number.

*** For knob printed in °F instead of °C, replace G with F or L with K in the reference.



Flexible silicone rubber heating pads, with remote electronic temperature control, on-off action.

Temperature limiter	Maximum temperature	Mounting	Temperature control	Silicone thickness (mm)	Type
Optional	200°C	Optional adhesive face	Electronic temperature control, on-off action	1.6 2.5 3.2	9AG

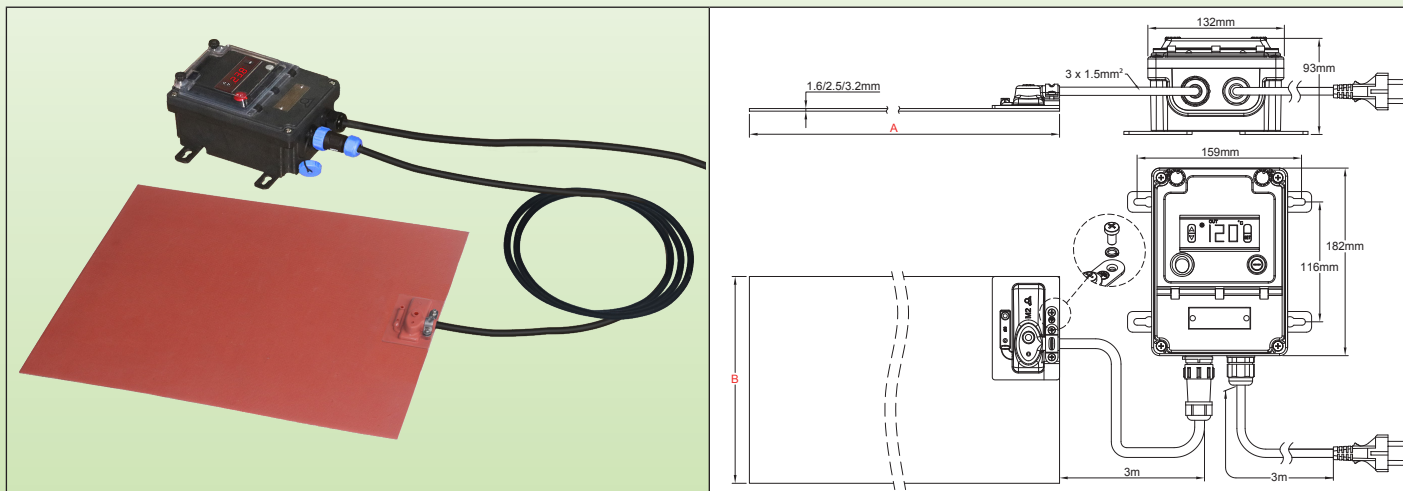

Main features

Flat and flexible silicone rubber heaters are made of fiberglass reinforced laminated silicone rubber sheets, vulcanized together through heat and high pressure on both sides of an embedded specially formed heating wire element. Fiberglass-reinforced silicone rubber gives the heater dimensional stability without sacrificing flexibility.

Silicone is used because of its high temperature resistance (Permanent temperature up to 200°C (390°F), high thermal conductivity ($\sim 7 \cdot 10^{-4} \text{ W/cm.K}$) and good electrical insulation properties ($\sim 12 \text{ KV/mm}$)

This series is distinguished by the use of a remote electronic control system, on-off action, simple to use, with digital display of the measured value, connection by waterproof connector for easy disconnection of the heater, and IP65 ingress protection class for the whole assembly. This allows its use in most of industrial applications

Other general particularities of these heaters are:

- Not affected by vibration or flexing,
- Lightweight,
- Comply with UL94-VO (flame retardant) and ROHS,
- Low smoke and low Toxicity,
- Silicone is non-toxic, and moisture and chemical resistant
- Very thin profile

Main applications

Combining high surface power and flexibility, flexible silicone heating elements are a simple and economical solution for heating surfaces. They are light, thin, heat quickly and evenly because they are in direct contact with the surface to be heated. Their construction is rugged, and they do not change dimensions during heating. They can be mounted on flat or cylindrical surfaces. Their bonding to the surfaces can be made by vulcanization, room temperature vulcanizable resin (RTV), or by application of a pressure-sensitive adhesive (PSA).

Some typical examples of applications are:

Autoclaves, Surveillance cameras, Mold heaters for polymerization of resins, Poultry incubators, Diesel fuel filters, Defrost, Cash Machines, Laboratory Equipment, Gyroscopes, Laminators, Heated Mirrors, Animal Feeders, Photocopiers, Food heating Trays, Heat Presses, Battery Heaters, Tanks for liquids, etc.

They can be made in multiple shapes, receive cutouts or holes. They can receive temperature sensors, temperature limiters, thermal fuses and thermostats.

Technical Features

Mounting: By a pressing system on the surface made by the user or by bonding with a room temperature vulcanizing silicone resin (RTV), or by adhesive.

Length (Dimension A): Upon customer request

Width (dimension B): Upon customer request (minimum 100mm)

Silicone foil minimum bending radius: 3.2 mm (0.125)

Ingress protection: IP65.

Because of permanent improvement of our products, drawings, descriptions, features used on these data sheets are for guidance only and can be modified without prior advice



Contact us

Web: www.ultimheat.com

Cat25-2-6-7

Flexible silicone rubber heating pads, with remote electronic temperature control, on-off action.

Minimum ambient temperature: -10°C (+15°F)

Voltage: 220-240VAC.

Power tolerance: ±10% at 20°C

Temperature control:

By electronic controller with digital display, On-Off action, set point adjustment range up to 120°C (NTC sensor), or 200°C (Pt100 sensor), relay output, located in an independent **waterproof** housing, **designed for wall mounting**. It is connected to the flexible silicone rubber heater by a cable equipped with a 5-pin **waterproof quick connector**, facilitating the connection and disconnection with the heater. It controls the temperature by means of a probe placed under a silicone boot on the outer surface of the heater.

Maximum rating 16A 230V (3600W).

Power density:

- 0.2 w/cm² (1.3W/in²) for plastic materials
- 0.75 w/cm² (4.8 w/inch²), for usual applications.
- 1 w/cm² (6.5 w/inch²) for fast heating applications.

Other values on request.

Thickness of the flexible silicone foil:

- 1.6mm for light application and small surfaces.
- 2.5mm for usual industrial applications.
- 3.2mm, for heavy duty applications requiring strong mechanical strength and reinforced insulation.

Quality control routine tests: Each element is 100% tested for continuity, resistance and insulation. Tests are made according to EN 60335-1 and EN 50106 standards. See technical introduction.

Dielectric Strength: 1750V AC.

Insulation resistance: ≥ 10 Megohms.

Operating temperature:

See in the technical introduction examples of the temperatures reached by flexible silicone heaters. They represent the temperature that may reach the heating belt if it is not correctly installed.

Connection cable:

Insulated rubber power supply cable, for industrial environments, 3 x 1.5mm² (3xAWG15) length 3m, Euro plug. UL plug on request.

Options:

- Customer design shape, with or without holes.
- Power supply 110/115V.
- Power cord with industrial plug 2-pole + earth 16A CEE (IEC60309).
- Surface mounted temperature limiter.
- Surface mounted temperature sensor (Pt100, NTC, thermocouple).
- Grounded mesh wire shield layer.
- Silicone foam insulation layer vulcanized on the external surface.

Safety standards:

The heaters have been designed in compliance with EEC Low Voltage Directive (LVD) 2006/95/EC and EMC directive 2004/108/EC. They must be installed in accordance with all local applicable instructions, codes, and regulations.

Main parts numbers in 220/240V, with 0.75W/cm² (4.8 w/inch²), surface power*

These references are incomplete. Full part number are issued when order is received. These heaters are manufactured only on order. Specify length and width						
Thermostat setting range	1.6mm thickness without adhesive	2.5mm thickness without adhesive	3.2mm thickness without adhesive	1.6mm thickness with adhesive	2.5mm thickness with adhesive	3.2mm thickness with adhesive
Part number with temperature controller adjustable up to 120°C (250°F)	9AGA8A----8--F30	9AGB8A----8--F30	9AGC8A----8--F30	9AGF8A----8--F30	9AGG8A----8--F30	9AGH8A----8--F30
Part number with temperature controller adjustable up to 200°C (390°F)	9AGA8B----8--F30	9AGB8B----8--F30	9AGC8B----8--F30	9AGF8B----8--F30	9AGG8B----8--F30	9AGH8B----8--F30

NB: the characters "-" in the part numbers are updated after selection of the length and the width of the silicone rubber heater

* - For surface load 0.2 w/cm² (1.3W/in²), replace 8G with 2G or 8L with 2L in the reference.

- For surface load 1 w/cm² (6.5 w/in²), replace 8G with BG or 8L with BL in the reference.

** For UL plug instead of Euro plug, replace F3 with E3 in the part number.

Because of permanent improvement of our products, drawings, descriptions, features used on these data sheets are for guidance only and can be modified without prior advice



Flexible silicone rubber heating pads, with remote electronic temperature control, double display, PID action.

Temperature limiter	Maximum temperature	Mounting	Temperature control	Silicone thickness (mm)	Type
Optional	200°C	Optional adhesive face	Electronic temperature control, PID action	1.6 2.5 3.2	9AJ

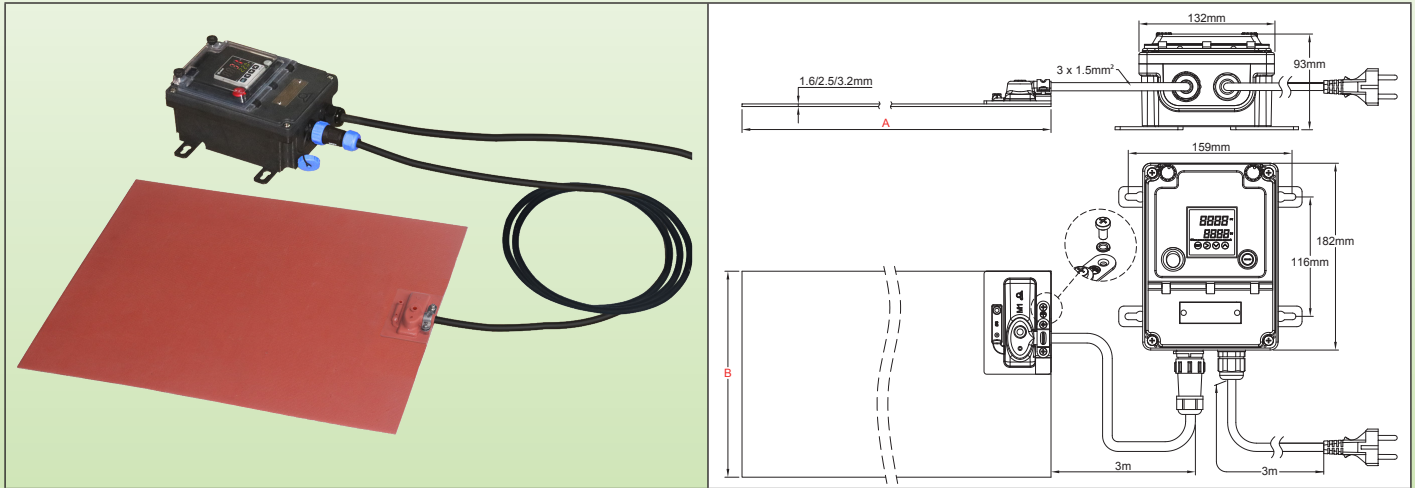

Main features

Flat and flexible silicone rubber heaters are made of fiberglass reinforced laminated silicone rubber sheets, vulcanized together through heat and high pressure on both sides of an embedded specially formed heating wire element. Fiberglass-reinforced silicone rubber gives the heater dimensional stability without sacrificing flexibility.

Silicone is used because of its high temperature resistance (Permanent temperature up to 200°C (390°F), high thermal conductivity ($\sim 7 \cdot 10^{-4} \text{ W/cm.K}$) and good electrical insulation properties ($\sim 12 \text{ KV/mm}$)

This series is distinguished by the use of a remote electronic control system, with PID action and automatic adjustment of parameters, with digital display of the measured value and digital display of the set point, connection by waterproof connector for easy disconnection of the heater, and IP65 ingress protection class for the whole assembly. This allows its use in most of industrial applications

Other general particularities of these heaters are:

- Not affected by vibration or flexing,
- Lightweight,
- Comply with UL94-VO (flame retardant) and ROHS,
- Low smoke and low Toxicity,
- Silicone is non-toxic, and moisture and chemical resistant
- Very thin profile

Main applications

Combining high surface power and flexibility, flexible silicone heating elements are a simple and economical solution for heating surfaces. They are light, thin, heat quickly and evenly because they are in direct contact with the surface to be heated. Their construction is rugged, and they do not change dimensions during heating. They can be mounted on flat or cylindrical surfaces. Their bonding to the surfaces can be made by vulcanization, room temperature vulcanizable resin (RTV), or by application of a pressure-sensitive adhesive (PSA).

Some typical examples of applications are:

Autoclaves, Surveillance cameras, Mold heaters for polymerization of resins, Poultry incubators, Diesel fuel filters, Defrost, Cash Machines, Laboratory Equipment, Gyroscopes, Laminators, Heated Mirrors, Animal Feeders, Photocopiers, Food heating Trays, Heat Presses, Battery Heaters, Tanks for liquids, etc.

They can be made in multiple shapes, receive cutouts or holes. They can receive temperature sensors, temperature limiters, thermal fuses and thermostats.

Mounting: By a pressing system on the surface made by the user or by bonding with a room temperature vulcanizing silicone resin (RTV), or by adhesive.

Length (Dimension A): Upon customer request

Width (dimension B): Upon customer request (minimum 100mm)

Silicone foil minimum bending radius: 3.2 mm (0.125)

Ingress protection: IP65.

Minimum ambient temperature: -10° C (+15° F)

Voltage: 220-240VAC.

Power tolerance: $\pm 10\%$ at 20° C

Because of permanent improvement of our products, drawings, descriptions, features used on these data sheets are for guidance only and can be modified without prior advice



[Contact us](#)

Web: www.ultimheat.com

Cat25-2-6-9

Flexible silicone rubber heating pads, with remote electronic temperature control, double display, PID action.

Temperature control: Controller with double display, of process value and of set-point, located in an independent **waterproof** housing, **designed for wall mounting**. It is connected to the flexible silicone rubber heater by a cable equipped with a 5-pin **waterproof quick connector**, facilitating the connection and disconnection with the heater. It controls the temperature by means of a probe placed under a silicone boot on the outer surface of the heater.

Action: PID with automatic parameters adjustment by auto-tune function.

Sensor input: Pt100

Power output: solid state relay, maximum 16A 230V.

Alarm: 3A 230V relay.

Display: 4 digits display configurable in °C or °F

Power supply: AC 220-230V 50-60Hz.

Accuracy: ±1°C (±2°F) or 0.3% ES± one digit.

Self-testing: open sensor circuit.

Ambient temperature: -10 to 60°C, 20 to 85% relative humidity, non-condensing.

Temperature display range: Configurable

Resolution: 0.1°

Read instruction manual before the setting of this temperature controller.

Power density:

- 0.2 w/cm² (1.3W/in²) for plastic materials
- 0.75 w/cm² (4.8 w/inch²), for usual applications.
- 1 w/cm² (6.5 w/inch²) for fast heating applications

Other values on request.

Thickness of the flexible silicone foil:

- 1.6mm for light application and small surfaces
- 2.5mm for usual industrial applications
- 3.2mm, for heavy duty applications requiring strong mechanical strength and reinforced insulation.

Quality control routine tests: Each element is 100% tested for continuity, resistance and insulation. Tests are made according to EN 60335-1 and EN 50106 standards. See technical introduction.

Dielectric Strength: 1750V AC.

Insulation resistance: ≥ 10 Megohms.

Operating temperature:

See in the technical introduction examples of the temperatures reached by flexible silicone heaters. They represent the temperature that may reach the heating belt if it is not correctly installed.

Connection cable:

Insulated rubber power supply cable, for industrial environments, 3 x 1.5mm² (3xAWG15) length 3m, Euro plug. UL plug on request.

Options:

- Customer design shape, with or without holes
- Power supply 110/115V
- Power cord with industrial plug 2-pole + earth 16A CEE (IEC60309).
- Surface mounted temperature limiter.
- Surface mounted temperature sensor (Pt100, NTC, thermocouple)
- Grounded mesh wire shield layer
- Silicone foam insulation layer vulcanized on the external surface

Safety standards:

The heaters have been designed in compliance with EEC Low Voltage Directive (LVD) 2006/95/EC and EMC directive 2004/108/EC. They must be installed in accordance with all local applicable instructions, codes, and regulations.

Main parts numbers in 220/240V, with 0.75W/cm² (4.8 w/inch²), surface power*

These references are incomplete. Full part number are issued when order is received. These heaters are manufactured only on order. Specify length and width						
Thermostat setting range	1.6mm thickness without adhesive	2.5mm thickness without adhesive	3.2mm thickness without adhesive	1.6mm thickness with adhesive	2.5mm thickness with adhesive	3.2mm thickness with adhesive
Part number with temperature controller adjustable up to 120°C (250°F)	9AJA8A----8--F30	9AJB8A----8--F30	9AJC8A----8--F30	9AJF8A----8--F30	9AJG8A----8--F30	9AJH8A----8--F30
Part number with temperature controller adjustable up to 200°C (390°F)	9AJA8B----8--F30	9AJB8B----8--F30	9AJC8B----8--F30	9AJF8B----8--F30	9AJG8B----8--F30	9AJH8B----8--F30

NB: the characters “-” in the part numbers are updated after selection of the length and the width of the silicone rubber heater

* - For surface load 0.2 w/cm² (1.3W/in²), replace 8G with 2G or 8L with 2L in the reference.

- For surface load 1 w/cm² (6.5 w/in²), replace 8G with BG or 8L with BL in the reference.

** For UL plug instead of Euro plug, replace F3 with E3 in the part number.

Because of permanent improvement of our products, drawings, descriptions, features used on these data sheets are for guidance only and can be modified without prior advice



Silicone rubber heating pads bonded on aluminium boards



Safety instructions for all industrial flat silicone rubber heaters described in this catalogue section

- Read the user manual before any use
- Protect the power supply circuit by a differential circuit breaker of 20mA sensitivity, with rating adapted to the model that must be connected to it.
- This supply circuit must be carried out by a qualified electrician and according to the local standards in force.
- The earth circuit must be compliant and connected.
- The heater must be disconnected when not used
- The heater must be disconnected during installation or de-installation.
- The heater must be stored in a dry place and protected from rodents and other animals during periods when it is not used.
- Connect the aluminum board to a grounding conductor.
- Do not cut or punch the surface.
- These appliances are not suitable for permanent outdoor use, and, upon their ingress protection rating (IP), must be protected from rain, dust and condensation.
- Do not operate above the rated safety temperature.
- Silicone heaters are not suitable for prolonged exposure to oils.
- The aluminum board must be in perfect contact with the surface to heat for all application with a surface power higher than 0.5W/cm². Use a thermal contact grease between both boards surface.
- These devices are not suitable for use in flammable or explosive areas.



Non flexible silicone heaters vulcanized on aluminium board, surface mounted adjustable thermostat.

Temperature limiters	Maximum temperature	Mounting	Temperature control	Silicone + aluminum thickness (mm)	Type
Optional	200°C	4 holes	Surface mounted thermostat	2,5 + 6	9AK

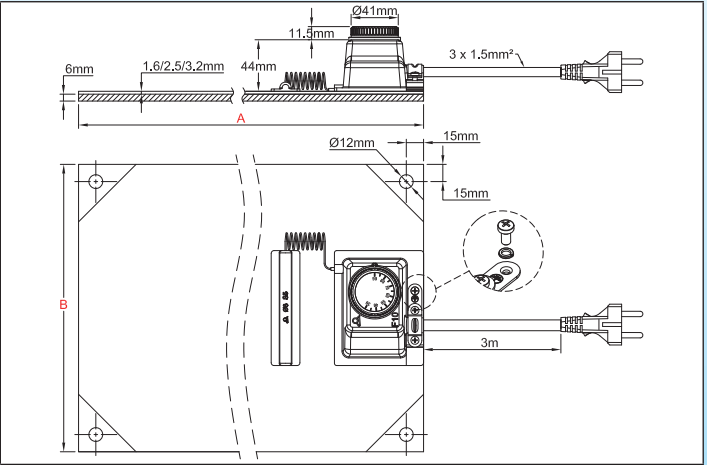
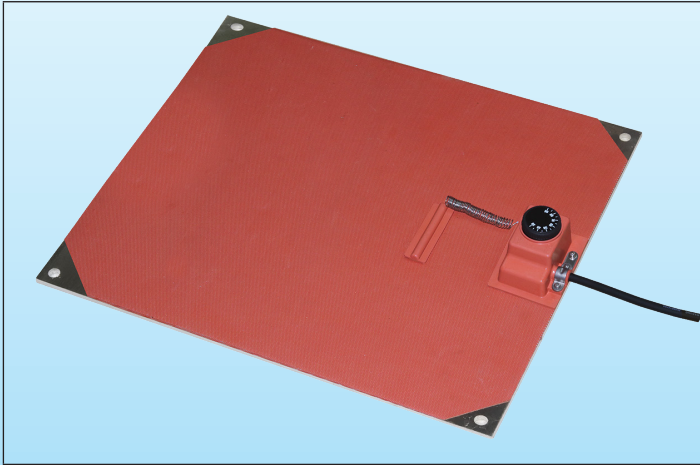

Main features

Non-flexible silicone rubber heaters are made of fiberglass reinforced laminated silicone rubber sheets, vulcanized together through heat and high pressure on both sides of an embedded specially formed heating wire element. Fiberglass-reinforced silicone rubber gives the heater dimensional stability.

The intimate bonding of the heater on a thick aluminum plate allows to increase the power surface load, and eases the mounting on flat surfaces in industrial applications

Silicone is used because of its high temperature resistance (Permanent temperature up to 200°C (390°F), high thermal conductivity ($\sim 7 \cdot 10^{-4}$ W/cm.K) and good electrical insulation properties (~ 12 KV/mm)

This series is distinguished by the use of a conventional thermostat mounted on the surface of the heating part, in a compact and economical design.

Other general particularities of these heaters are:

- Not affected by vibration or flexing,
- Lightweight,
- Comply with UL94-VO (flame retardant) and ROHS,
- Low smoke and low toxicity,
- Silicone is non-toxic, and moisture and chemical resistant
- Very thin profile

Main applications

Silicone heating elements on aluminum plates are a simple and industrial solution for heating flat surfaces. They are sturdy, easy to install and heat quickly and evenly.

Some typical examples of applications are:

Heating of hoppers, electrical cabinets, hot plates for the food industry, reheating tank bottoms.

In addition to their temperature control system, they can receive temperature sensors, temperature limiters, thermal fuses.

Technical features

Mounting: By 4 holes dia. 12mm located at the 4 corners, at 15mm from edges

Length (Dimension A): Upon customer request (minimum 300mm)

Width (dimension B): Upon customer request (minimum 100mm)

Ingress protection: IP54.

Minimum ambient temperature: -10°C (+15°F)

Voltage: 220-240VAC.

Power tolerance: $\pm 10\%$ at 20°C

Temperature control: Single pole bulb and capillary thermostat, adjustable from 20°C to 110°C (+50~230°F) or from 50 to 200°C (120-390°F). Rating 16A 230V (3600W).

Power density:

- 0.2 w/cm² (1.3W/in²) for plastic materials
- 0.75 w/cm² (4.8 w/inch²), for usual applications.
- 1 w/cm² (6.5 w/inch²) for fast heating applications.
- 1.4 w/cm² (9.1 w/inch²) for huge power applications



Non flexible silicone heaters vulcanized on aluminium board, surface mounted adjustable thermostat.

Other values on request.

Thickness of the flexible silicone foil: 2.5mm

Thickness of the aluminium board: 6 mm (other values on request).

Quality control routine tests: Each element is 100% tested for continuity, resistance and insulation. Tests are made according to EN 60335-1 and EN 50106 standards. See technical introduction.

Dielectric Strength: 1750V AC.

Insulation resistance: ≥ 10 Megohms.

Operating temperature:

See in the technical introduction examples of the temperatures reached by these heaters. They represent the temperature that they may reach if they are not correctly installed.

Connection cable:

Insulated rubber power supply cable, for industrial environments, 3 x 1.5mm² (3xAWG15) length 3m, Euro plug. UL plug on request.

Options:

- Power supply 110/115V
- Power cord with industrial plug 2-pole + earth 16A CEE (IEC60309).
- Surface mounted temperature limiter.
- Surface mounted temperature sensor (Pt100, NTC, thermocouple).
- Grounded mesh wire shield layer.
- Silicone foam insulation layer vulcanized on the external surface.

Safety standards:

The heaters have been designed in compliance with EEC Low Voltage Directive (LVD) 2006/95/EC and EMC directive 2004/108/EC. They must be installed in accordance with all local applicable instructions, codes, and regulations.

Main parts numbers in 220/240V

Thermostat setting range	W/cm ² (W/in ²)	300x350mm	Power (Watts, 230V)	350x400mm	Power (Watts, 230V)	400x 450mm	Power (Watts, 230V)	500x600mm	Power (Watts, 230V)
20~110°C** (+50~230°F)	0.2 (1.3)	9AKB2GAB6A814F30	140	9AKB2GBC6A820F30	200	9AKB2GCD6A828F30	280	9AKB2GEG6A850F30	500
	0.75 (4.8)	9AKB8GAB6A832F30	320	9AKB8GBC6A845F30	450	9AKB8GCD6A862F30	620	9AKB8GEG6A8--F30	1100
	1 (6.5)	9AKBBGAB6A870F30	700	9AKBBGBC6A8A0F30	1000	9AKBBGCD6A8A4F30	1400	9AKBBGEG6A8B5F30	2500
	1.4 (9.1)	9AKBFGAB6A8A0F30	1000	9AKBFGBC6A8A4F30	1400	9AKBFGCD6A8A9F30	1900	9AKBFGEG6A8C5F30	3500
50 ~ 200°C** (120~390°F)	0.2 (1.3)	9AKB2LAB6A814F30	140	9AKB2LBC6A820F30	200	9AKB2LCD6A828F30	280	9AKB2LEG6A850F30	500
	0.75 (4.8)	9AKB8LAB6A832F30	320	9AKB8LBC6A845F30	450	9AKB8LCD6A862F30	620	9AKB8LEG6A8A1F30	1100
	1 (6.5)	9AKBBLAB6A870F30	700	9AKBBLBC6A8A0F30	1000	9AKBBLCD6A8A4F30	1400	9AKBBLEG6A8B5F30	2500
	1.4 (9.1)	9AKBFLAB6A8A0F30	1000	9AKBFLBC6A8A4F30	1400	9AKBFLCD6A8A9F30	1900	9AKBFLEG6A8C5F30	3500

* For UL plug instead of Euro plug, replace F3 with E3 in the part number.

** For knob printed in °F instead of °C, replace G with F or L with K in the reference.

Because of permanent improvement of our products, drawings, descriptions, features used on these data sheets are for guidance only and can be modified without prior advice



Non flexible silicone heaters vulcanized on aluminium board, with remote electronic temperature control, on-off action.

Temperature limiters	Maximum temperature	Mounting	Temperature control	Silicone + aluminum thickness (mm)	Type
Optional	200°C	4 holes	Electronic temperature controller, on-off action	2,5 + 6	9AL

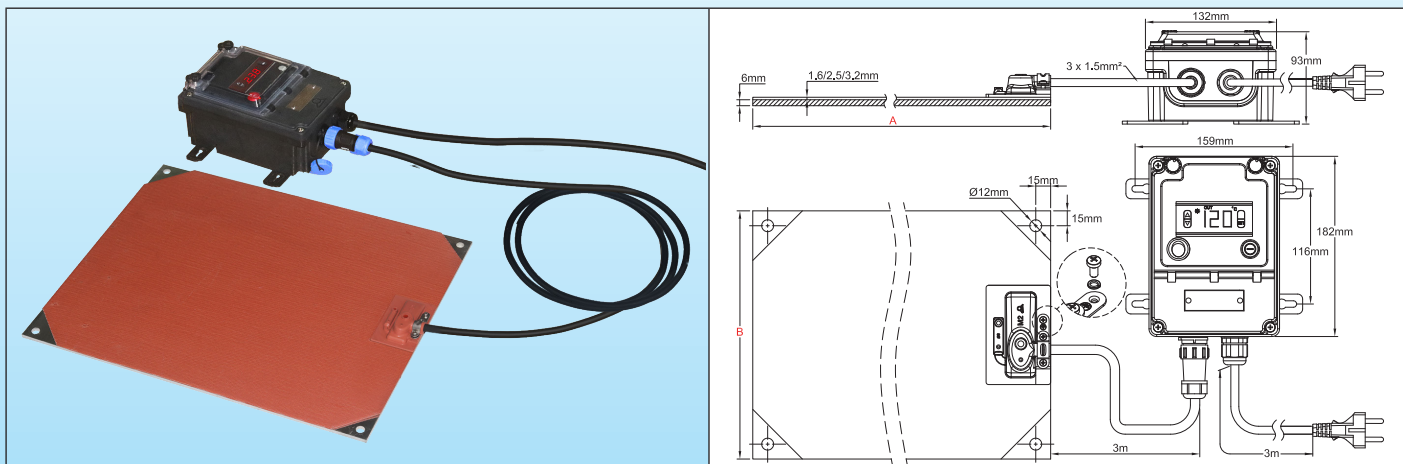

Main features

Non-flexible silicone rubber heaters are made of fiberglass reinforced laminated silicone rubber sheets, vulcanized together through heat and high pressure on both sides of an embedded specially formed heating wire element. Fiberglass-reinforced silicone rubber gives the heater dimensional stability.

The intimate bonding of the heater on a thick aluminum plate allows to increase the power surface load, and eases the mounting on flat surfaces in industrial applications

Silicone is used because of its high temperature resistance (Permanent temperature up to 200°C (390°F), high thermal conductivity ($\sim 7 \cdot 10^{-4} \text{ W/cm.K}$) and good electrical insulation properties ($\sim 12 \text{ KV/mm}$)

This series is distinguished by the use of a remote electronic control system, on-off action, simple to use, with digital display of the measured value, connection by waterproof connector for easy disconnection of the heater, and IP65 ingress protection class for the whole assembly. This allows its use in most of industrial applications

Other general particularities of these heaters are:

- Not affected by vibration or flexing,
- Lightweight,
- Comply with UL94-VO (flame retardant) and ROHS,
- Low smoke and low Toxicity,
- Silicone is non-toxic, and moisture and chemical resistant

Main applications

Silicone heating elements on aluminum plates are a simple and industrial solution for heating flat surfaces. They are sturdy, easy to install and heat quickly and evenly.

Some typical examples of applications are:

Heating of hoppers, electrical cabinets, hot plates for the food industry, reheating tank bottoms.

In addition to their temperature control system, they can receive temperature sensors, temperature limiters, thermal fuses.

Technical features

Mounting: By 4 holes dia. 12mm located at the 4 corners, at 15mm from edges

Length (Dimension A): Upon customer request (minimum 300mm)

Width (dimension B): Upon customer request (minimum 100mm)

Ingress protection: IP65.

Minimum ambient temperature: -10° C (+15° F)

Voltage: 220-240VAC.

Power tolerance: $\pm 10\%$ at 20°C

Temperature control:

By electronic controller with digital display, On-Off action, set point adjustment range up to 120°C (NTC sensor), or 200°C (Pt100 sensor), relay output, located in an independent **waterproof** housing, **designed for wall mounting**. It is connected to the flexible silicone rubber heater by a cable equipped with a 5-pin **waterproof quick connector**, facilitating the connection and disconnection with the heater. It controls the temperature by means of a probe placed under a silicone boot on the outer surface of the heater.



Non flexible silicone heaters vulcanized on aluminium board, with remote electronic temperature control, on-off action.

Maximum rating 16A 230V (3600W).

Power density:

- 0.2 w/cm² (1.3W/in²) for plastic materials
- 0.75 w/cm² (4.8 w/inch²), for usual applications.
- 1 w/cm² (6.5 w/inch²) for fast heating applications.
- 1.4 w/cm² (9.1 w/inch²) for huge power applications

Other values on request.

Thickness of the flexible silicone foil: 2.5mm

Thickness of the aluminum board: 6 mm (other values on request).

Quality control routine tests: Each element is 100% tested for continuity, resistance and insulation. Tests are made according to EN 60335-1 and EN 50106 standards. See technical introduction.

Dielectric Strength: 1750V AC.

Insulation resistance: ≥ 10 Megohms.

Operating temperature:

See in the technical introduction examples of the temperatures reached by these heaters. They represent the temperature that they may reach if they are not correctly installed.

Connection cable:

Insulated rubber power supply cable, for industrial environments, 3 x 1.5mm² (3xAWG15) length 3m, Euro plug. UL plug on request.

Options:

- Power supply 110/115V
- Power cord with industrial plug 2-pole + earth 16A CEE (IEC60309).
- Surface mounted temperature limiter.
- Grounded mesh wire shield layer
- Silicone foam insulation layer vulcanized on the external surface

Safety standards:

The heaters have been designed in compliance with EEC Low Voltage Directive (LVD) 2006/95/EC and EMC directive 2004/108/EC. They must be installed in accordance with all local applicable instructions, codes, and regulations.

Main parts numbers in 220/240V

Temperature setting range	W/cm ² (W/in ²)	300x350mm	Power (Watts, 230V)	350x400mm	Power (Watts, 230V)	400x 450mm	Power (Watts, 230V)	500x600mm	Power (Watts, 230V)
Part number with temperature controller adjustable up to 120°C (250°F)	0.2 (1.3)	9ALB2AAB6A814F30	140	9ALB2ABC6A820F30	200	9ALB2ACD6A828F30	280	9ALB2AEA6A850F30	500
	0.75 (4.8)	9ALB8AAB6A832F30	320	9ALB8ABC6A845F30	450	9ALB8ACD6A862F30	620	9ALB8AEA6A8--F30	1100
	1 (6.5)	9ALBBAA6A870F30	700	9ALBBABC6A8A0F30	1000	9ALBBACD6A8A4F30	1400	9ALBBAEA6A8B5F30	2500
	1.4 (9.1)	9ALBFAAB6A8A0F30	1000	9ALBFABC6A8A4F30	1400	9ALBFACD6A8A9F30	1900	9ALBFAEA6A8C5F30	3500
Part number with temperature controller adjustable up to 200°C (390°F)	0.2 (1.3)	9ALB2BAB6A814F30	140	9ALB2BBC6A820F30	200	9ALB2BCD6A828F30	280	9ALB2BEG6A850F30	500
	0.75 (4.8)	9ALB8BAB6A832F30	320	9ALB8BBC6A845F30	450	9ALB8BCD6A862F30	620	9ALB8BEG6A8A1F30	1100
	1 (6.5)	9ALBBBAB6A870F30	700	9ALBBBBC6A8A0F30	1000	9ALBBBCD6A8A4F30	1400	9ALBBBEG6A8B5F30	2500
	1.4 (9.1)	9ALBBLAB6A8A0F30	1000	9ALBBLBC6A8A4F30	1400	9ALBBLCD6A8A9F30	1900	9ALBBLEG6A8C5F30	3500

* For UL plug instead of Euro plug, replace F3 with E3 in the part number.

Because of permanent improvement of our products, drawings, descriptions, features used on these data sheets are for guidance only and can be modified without prior advice



Non flexible silicone heaters vulcanized on aluminium board, with remote electronic temperature control, double display, PID action.

Temperature limiters	Maximum temperature	Mounting	Temperature control	Silicone + aluminum thickness (mm)	Type
Optional	200°C	4 holes	Electronic temperature control, PID action	2.5 + 6	9AM

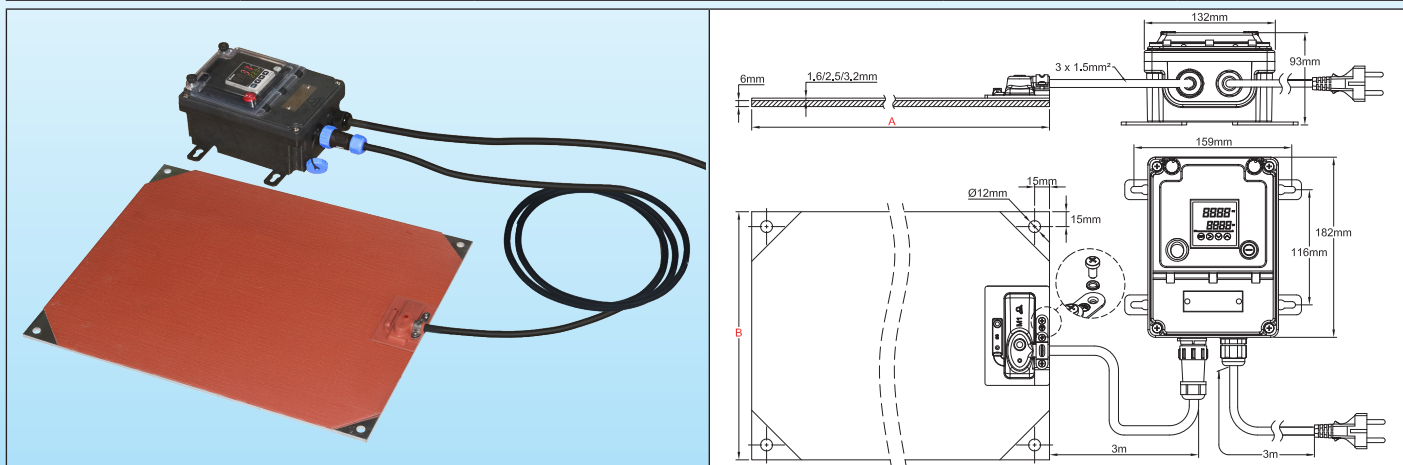

Main features

Non-flexible silicone rubber heaters are made of fiberglass reinforced laminated silicone rubber sheets, vulcanized together through heat and high pressure on both sides of an embedded specially formed heating wire element. Fiberglass-reinforced silicone rubber gives the heater dimensional stability.

The intimate bonding of the heater on a thick aluminum plate allows to increase the power surface load, and eases the mounting on flat surfaces in industrial applications

Silicone is used because of its high temperature resistance (Permanent temperature up to 200°C (390°F), high thermal conductivity ($\sim 7 \cdot 10^{-4}$ W/cm.K) and good electrical insulation properties (~ 12 KV/mm)

This series is distinguished by the use of a remote electronic control system, with PID action and automatic adjustment of parameters, with digital display of the measured value and digital display of the set point, connection by waterproof connector for easy disconnection of the heater, and IP65 ingress protection class for the whole assembly. This allows its use in most of industrial applications

Other general particularities of these heaters are:

- Not affected by vibration or flexing,
- Lightweight,
- Comply with UL94-VO (flame retardant) and ROHS,
- Low smoke and low Toxicity,
- Silicone is non-toxic, and moisture and chemical resistant

Main applications

Silicone heating elements on aluminum plates are a simple and industrial solution for heating flat surfaces. They are sturdy, easy to install and heat quickly and evenly.

Some typical examples of applications are:

Heating of hoppers, electrical cabinets, hot plates for the food industry, reheating tank bottoms.

In addition to their temperature control system, they can receive temperature sensors, temperature limiters, thermal fuses.

Technical features

Mounting: By 4 holes dia. 12mm located at the 4 corners, at 15mm from edges

Length (Dimension A): Upon customer request (minimum 300mm)

Width (dimension B): Upon customer request (minimum 100mm)

Ingress protection: IP65.

Minimum ambient temperature: -10°C (+15°F)

Voltage: 220-240VAC.

Power tolerance: $\pm 10\%$ at 20°C

Temperature control: Controller with double display, of process value and of set-point, located in an independent waterproof housing, designed for wall mounting. It is connected to the flexible silicone rubber heater by a cable equipped with a 5-pin waterproof quick connector, facilitating the connection and disconnection with the heater. It controls the temperature by means of a probe placed under a silicone boot on the outer surface of the heater.

Action: PID with automatic parameters adjustment by auto-tune function.



Non flexible silicone heaters vulcanized on aluminium board, with remote electronic temperature control, double display, PID action.

Sensor input: Pt100

Power output: solid state relay, maximum 16A 230V.

Alarm: 3A 230V relay.

Display: 4 digits display configurable in °C or °F

Power supply: AC 220-230V 50-60Hz.

Accuracy: $\pm 1^{\circ}\text{C}$ ($\pm 2^{\circ}\text{F}$) or 0.3% ES \pm one digit.

Self-testing: open sensor circuit.

Ambient temperature: -10 to 60°C, 20 to 85% relative humidity, non-condensing.

Temperature display range: Configurable

Resolution: 0.1°

Read instruction manual before the setting of this temperature controller.

Power density:

- 0.2 w/cm² (1.3W/in²) for plastic materials
- 0.75 w/cm² (4.8 w/inch²), for usual applications.
- 1 w/cm² (6.5 w/inch²) for fast heating applications.
- 1.4 w/cm² (9.1 w/inch²) for huge power applications

Other values on request.

Thickness of the flexible silicone foil: 2.5mm

Thickness of the aluminum board: 6 mm (other values on request).

Quality control routine tests: Each element is 100% tested for continuity, resistance and insulation. Tests are made according to EN 60335-1 and EN 50106 standards. See technical introduction.

Dielectric Strength: 1750V AC.

Insulation resistance: ≥ 10 Megohms.

Operating temperature:

See in the technical introduction examples of the temperatures reached by these heaters. They represent the temperature that they may reach if they are not correctly installed.

Connection cable:

Insulated rubber power supply cable, for industrial environments, 3 x 1.5mm² (3xAWG15) length 3m, Euro plug. UL plug on request.

Options:

- Power supply 110/115V
- Power cord with industrial plug 2-pole + earth 16A CEE (IEC60309).
- Surface mounted temperature limiter.
- Grounded mesh wire shield layer
- Silicone foam insulation layer vulcanized on the external surface

Safety standards:

The heaters have been designed in compliance with EEC Low Voltage Directive (LVD) 2006/95/EC and EMC directive 2004/108/EC. They must be installed in accordance with all local applicable instructions, codes, and regulations.

Main parts numbers in 220/240V

W/cm ² (W/in ²)	300x350mm	Power (Watts, 230V)	350x400mm	Power (Watts, 230V)	400x 450mm	Power (Watts, 230V)	500x600mm	Power (Watts, 230V)
0.2 (1.3)	9AMB2CAB6A814F30	140	9AMB2CBC6A820F30	200	9AMB2CCD6A828F30	280	9AMB2CEG6A850F30	500
0.75 (4.8)	9AMB8CB6A832F30	320	9AMB8CBC6A845F30	450	9AMB8CCD6A862F30	620	9AMB8CEG6A8A1F30	1100
1 (6.5)	9AMBBCAB6A870F30	700	9AMBBCBC6A8A0F30	1000	9AMBBCCD6A8A4F30	1400	9AMBBCEG6A8B5F30	2500
1.4 (9.1)	9AMBCCB6A8A0F30	1000	9AMBCCBC6A8A4F30	1400	9AMBCCD6A8A9F30	1900	9AMBCEG6A8C5F30	3500

* For UL plug instead of Euro plug, replace F3 with E3 in the part number.

Temperature controls and limiters

Temperature sensors



Electronic temperature control boxes for remote control. On-Off or PID action



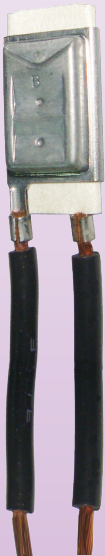
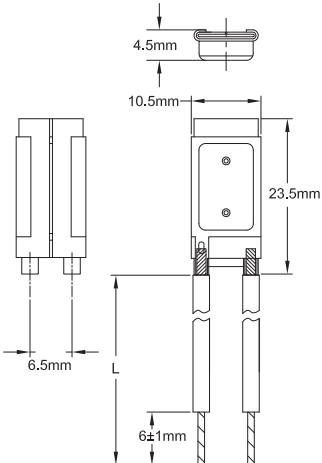

Fixed setting temperature limiters. (Selection of models usable on silicone heating elements).

Temperature range	Electric rating	Contact style	Temperature sensing device	Temperature setting	Types
50- 200°C (120- 390°F)	Up to 15A	Snap action	Bimetal	Fixed setting	UJA, 4A, 4903 4R05, 4T

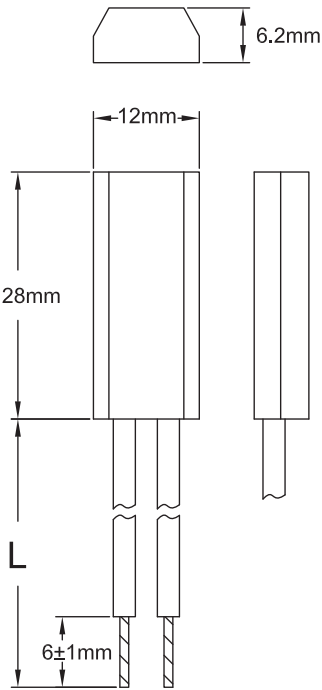
Picture	drawing	text	references
		<p>Construction: Bimetal crossed by the current. The current passing in the bimetal causes its heating by Joule effect. The calibration temperature must take into account this heating.</p> <p>Housing: 11.7 x 4.1 x 23.6 mm, body is live.</p> <p>Electric rating: 5A 120 VAC, 4A 240 VAC, 100000 cycles (UL) and 22A 120V, 13A 250V, 10000 cycles (VDE)</p> <p>Calibration range: 50°C to 160°C. Tolerances +/- 5°C and +/- 7°C</p> <p>Contact action: Snap action, instantaneous opening and closing contact, suitable for 120 and 240V applications</p> <p>Differential: The differential between opening and closing of the contact can be specified between 2 and 40 °C</p> <p>Calibration: Fixed setting, factory-made, not modifiable by the user.</p> <p>Terminals: Can be supplied with factory set wires.</p> <p>Part numbers: The full part number and the technical sheet are issued when products are ordered</p> <p>Compatible with: 9BFL1 silicone protective boot, which can be vulcanized or glued. (See technical pages on silicone boots).</p>	UJA
		<p>Construction: Bimetal crossed by the current. The current passing in the bimetal causes its heating by Joule effect. The calibration temperature must take into account this heating.</p> <p>Housing: 28 x 12 x 6.2 mm, PPS body is waterproof and electrically insulated.</p> <p>Electric rating: 9A 250V, 10000 cycles</p> <p>Calibration range: 50°C to 150°C. Tolerances +/- 5°C and +/- 7°C</p> <p>Contact action: Snap action, instantaneous opening and closing contact.</p> <p>Differential: 7±4°C (16±9°F)</p> <p>Calibration: Fixed setting, factory-made, not modifiable by the user.</p> <p>Terminals: XLPE insulated AWG20 wires, length made on order.</p> <p>Part numbers: The full part number and the technical sheet are issued when products are ordered.</p> <p>Compatible with: These waterproof limiters can be glued directly on the silicone heater or be put under a 9BFL5 silicone protective boot, which can be vulcanized or glued. (See technical pages on silicone boots).</p>	4A

Because of permanent improvement of our products, drawings, descriptions, features used on these data sheets are for guidance only and can be modified without prior advice







Contact us

Web: www.ultimheat.com

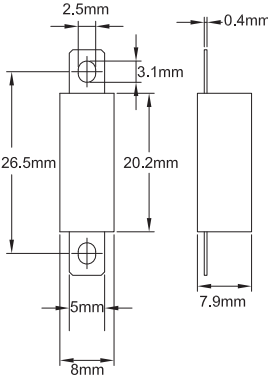
Cat25-2-8-3

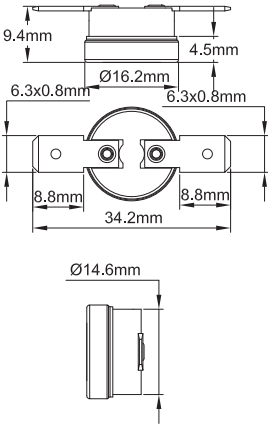
Fixed setting temperature limiters. (Selection of models usable on silicone heating elements).

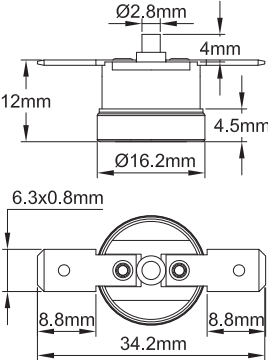
		<p>Construction: Bimetal not crossed by the current. Current flowing through the thermostat does not change its opening temperature.</p> <p>Case: 20.2 x 5 x 5.9mm, in PPS (not waterproof)</p> <p>Sensing element: Bimetal disc, snap-action contact</p> <p>Set Point: Factory set, 60 °C to + 160°C (140 to 320°F). Not adjustable by the user. Standard tolerance from ± 4 °C to ± 6 °C (± 9 °F to ± 16 °F), depending on models.</p> <p>Connection: by solder terminals.</p> <p>Differential: 7 ± 4 °C (16 ± 9 °F).</p> <p>Mounting: no flange or bracket</p> <p>Electrical rating: 10A at 240V (resistive, alternating current)</p> <p>Part numbers: These products are made to order only. (M.O.Q apply). The full part number and the technical sheet are issued when products are ordered.</p> <p>Compatible with: 9BFL6 silicone boot, (see technical pages on silicone caps), which can be vulcanized or glued.</p>	4T
		<p>Construction: Bimetal not crossed by the current. Current flowing through the thermostat does not change its opening temperature.</p> <p>Body: Phenolic resin (ceramic body above 150°C)</p> <p>Sensing element: Bimetal disc, snap-action contact</p> <p>Set Point: Factory set from -15 to + 150°C (5 to 302°F) with phenolic resin body, and 150 to 200°C (302 to 392°F) with ceramic body. Not adjustable by the user. Standard tolerance from ± 4 °C to ± 6 °C (± 9 °F to ± 14 °F) depending on models.</p> <p>Connection: 6.3 tabs or solder terminals</p> <p>Differential: Factory set. Standard values from 5°C to 25°C, (9°F to 50°F)</p> <p>Bracket: Without bracket</p> <p>Electrical rating: 15A at 125VAC, 10A at 240VAC, 100,000 cycles (resistive load)</p> <p>Part numbers: These products are made to order only. (M.O.Q apply). The full part number and the technical sheet are issued when products are ordered.</p> <p>Compatible with: 9BFL2; 9BFL3; 9BFP1; 9BFV1; 9BFV2; 9BFV3, silicone boots, which can be vulcanized or glued. (See technical pages on silicone boots).</p>	4903
		<p>Construction: Bimetal not crossed by the current. Current flowing through the thermostat does not change its opening temperature.</p> <p>Body: Phenolic resin (ceramic body above 150°C)</p> <p>Sensing element: Bimetal disc, snap-action contact</p> <p>Set Point: Factory set from -15 to + 150°C (5 to 302°F) with phenolic resin body, and 150 to 200°C (302 to 392°F) with ceramic body. Not adjustable by the user. Standard tolerance from ± 4 °C to ± 6 °C (± 9 °F to ± 14 °F) depending on models.</p> <p>Connection: 6.3 tabs or solder terminals</p> <p>Differential: Manual reset</p> <p>Bracket: Without bracket</p> <p>Electrical rating: 15A at 125VAC, 10A at 240VAC, 100,000 cycles (resistive load)</p> <p>Part numbers: These products are made to order only. (M.O.Q apply). The full part number and the technical sheet are issued when products are ordered.</p> <p>Compatible with: 9BFL4 silicone boot, which can be vulcanized or glued. (See technical pages on silicone boots)</p>	4R05

Note: These temperature limiters are not manufactured by Ultimheat, and the information given is that of our suppliers.

Because of permanent improvement of our products, drawings, descriptions, features used on these data sheets are for guidance only and can be modified without prior advice

Bimetal surface temperature control thermostat, adjustable set point.

(Selection of models usable on silicone heating elements).

Temperature range	Electric rating	Contact style	Temperature sensing device	Temperature setting	Types
50- 200°C (120- 390°F)	Up to 7.5A	Slow break contact	Bimetal	Set point adjustable by customer	IB

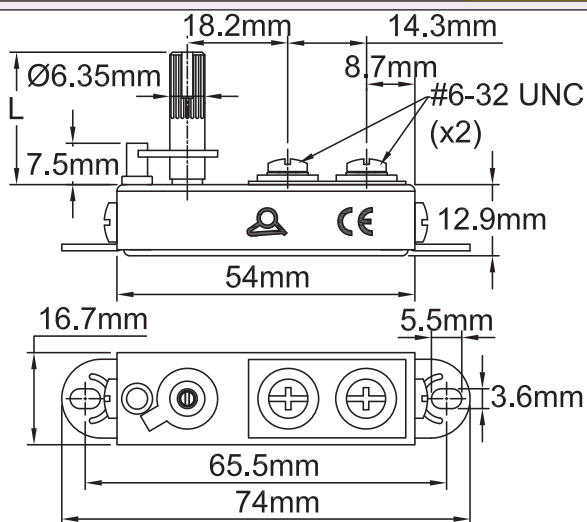
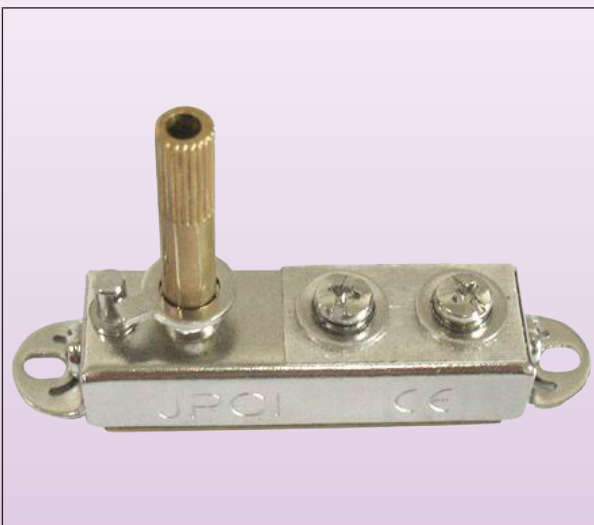

Applications

Adjustable and low differential device to control the surface temperature on flexible heating elements.

Main Features

Dimensions: 58.5 x 17.5 x 17.5 mm (not including shaft)

Material: metal and ceramic body

Temperature sensing element: high thermal conductivity copper alloy.

Terminals: 2 screw terminals 6-32 UNC

Set point adjustment: dia. 6.35 mm shaft, 32 mm length, rotation angle 310 ° (other shaft lengths, or screwdriver or fixed setting available on request)

Mounting: To be mounted on the surface of the silicone heater with a silicone boot 9BFF4, which can be vulcanized or glued. (See technical pages on silicone caps).

Electrical rating: 1500 watts 110/240VAC, resistive (slow break action). In 220-240V applications, it may be necessary to provide an anti-radio interference device on the circuit to comply with European EMC rules.

Contact: Slow break, open by temperature rise

Differential: Less than 1°C (2°F)

Maximum ambient temperature on the thermostat: 300 ° C (570 ° F)

Approval: Complies with UL 873

Main part numbers used on flexible silicone heaters

Part numbers	Shaft length (L)	Calibration value at high stop °C(°F)
IBK2000632313001	32mm	150 (300)
IBK2000632313901	32mm	200 (390)

Accessory

Knob for 6.35 mm shaft. Black PPS material, white printed crescent. Maximum temperature on the knob: 200°C (390°F)

Part number:
66MB060000010MW

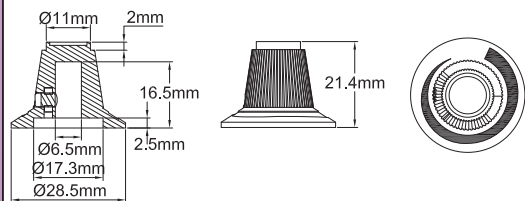

Because of permanent improvement of our products, drawings, descriptions, features used on these data sheets are for guidance only and can be modified without prior advice



Contact us

Web: www.ultimheat.com

Cat25-2-8-5

Single pole bulb and capillary surface temperature control thermostat, with adjustable set point
 (Selection of models usable on silicone heating elements).

Temperature range	Electric rating	Contact style	Temperature sensing device	Temperature setting	Types
50- 200°C (120- 390°F)	16A 250V	Snap action single pole contact	Liquid expansion	Set point adjustable by customer	8G

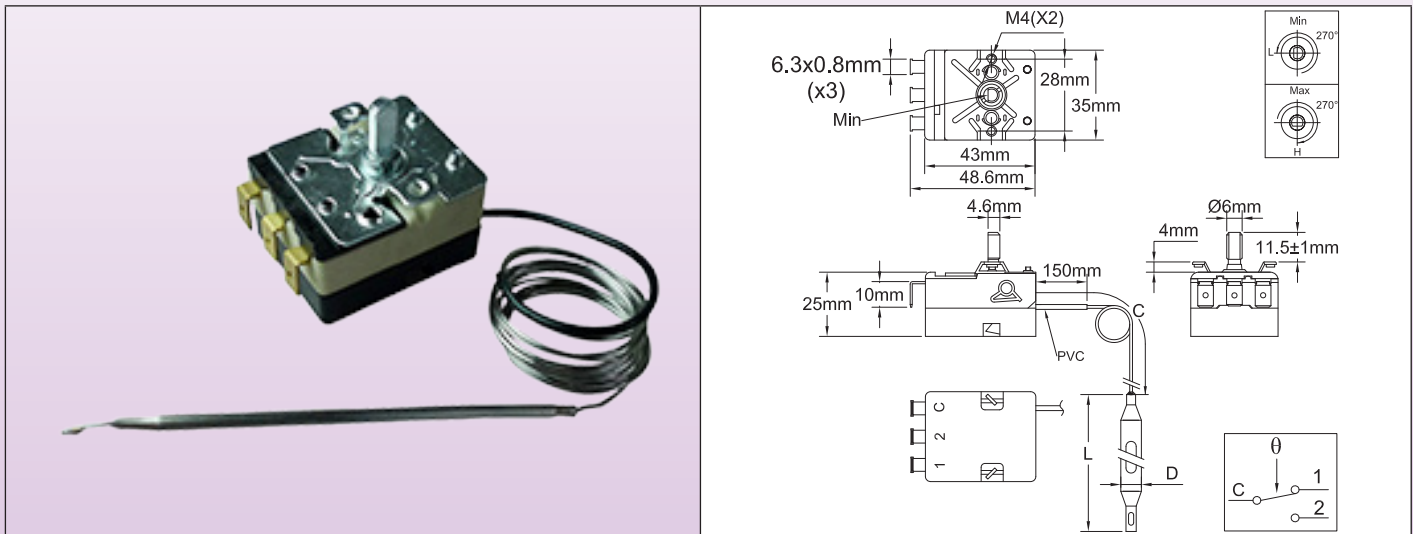

Applications

Adjustable thermostat, with snap action contact to control the surface temperature on flexible heaters.

Body dimensions: 43 x 35 x 29 mm (terminals not included)

Bulb and capillary: Stainless steel. Bending radius 5mm minimum

Temperature sensing: liquid filled bulb and capillary.

Terminals: 6.3 x 0.8mm tabs.

Set point adjustment: Shaft, length 11.5 mm, diameter 6mm with 4.6mm flat

Mounting: 2 holes with M4 thread, 28 mm distance between axis. The body of the thermostat is mounted on the surface of the heating element by means of the silicone boot 9BFF10 including a silicone foam sheet insulating the body of the thermostat from the surface temperature. The bulb is mounted outside of the thermostat boot by means of the boots 9BFS6 (for bulbs up to 80mm length) or 9 BFS7 (or bulbs up to 100mm length), which can be vulcanized or glued. (See technical pages on silicone boots).

Contact: single pole, snap action.

Electrical rating:16A (2,6) 250VAC,100,000 cycles.

Main part numbers used on flexible silicone heaters

Part number	Temperature range °C (°F)	Capillary length (C, mm)	Bulb diameter (D, mm)	Bulb length (E, mm)	Max temperature on bulb °C (°F)
8GB030110AA80001	30-110°C (85-230°F)	250	8	55±5	140°C (284°F)
8GB050200AA60001	50-200°C (120-390°F)	250	6	65±5	230°C (446°F)

Accessories: Printed knobs

°C Printing		°F Printing	
30-110°C	50-200°C	85-230°F	120-390°F
66MZ0060301101FW	66MZ0060502001FW	66MZ0060502001FX	66MZ0060502001FX

Because of permanent improvement of our products, drawings, descriptions, features used on these data sheets are for guidance only and can be modified without prior advice



3 pole bulb and capillary surface temperature control thermostat, with adjustable set point. (Selection of models usable on silicone heating elements).

Temperature range	Electric rating	Contact style	Temperature sensing device	Temperature setting	Types
50- 200°C (120- 390°F)	3x16A 250V	Snap action 3 pole contact	Liquid expansion	Set point adjustable by customer	8C

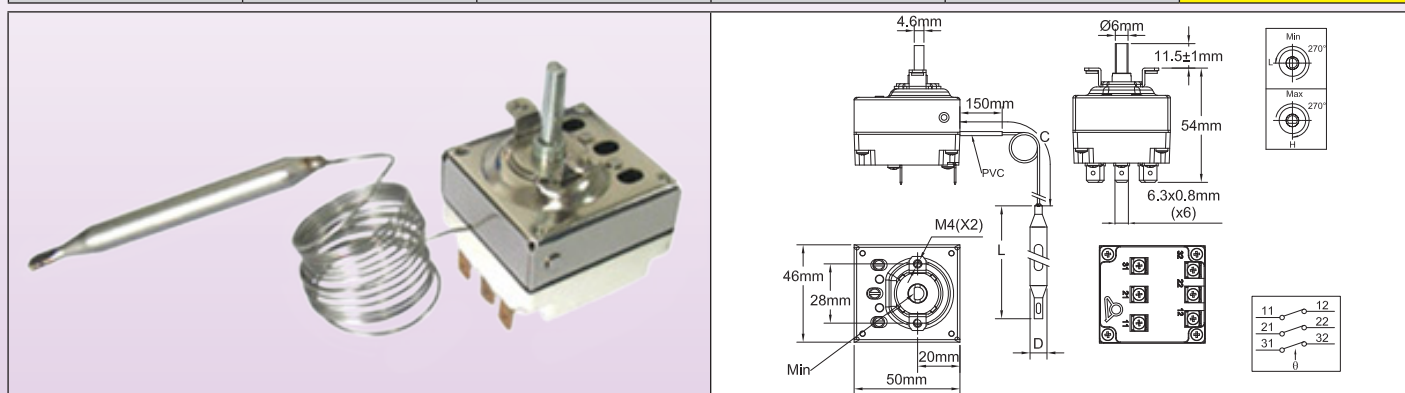

Applications

Adjustable thermostat, with **snap action contact** to control the surface temperature on **3 phase flexible heaters**.

Body dimensions: 46 x 50 x 45 mm (terminals not included)

Bulb and capillary: Stainless steel. Bending radius 5mm minimum

Temperature sensing: liquid filled bulb and capillary.

Terminals: 6.3 x 0.8mm tabs.

Set point adjustment: Shaft, length 11.5 mm, diameter 6mm with 4.6mm flat

Mounting: 2 holes with M4 thread, 28 mm distance between axis. The body of the thermostat is mounted on the surface of the heating element by means of the silicone boot 9BFF14 including a silicone foam sheet insulating the body of the thermostat from the surface temperature. The bulb is mounted outside of the thermostat boot by means of the boots 9BFS6 (for bulbs up to 80mm length) or 9 BFS7 f(or bulbs up to 100mm length), which can be vulcanized or glued. (See technical pages on silicone boots).

Contact: 3 pole, snap action.

Electrical rating: 3 x 16A (2,6) 250VAC, 100,000 cycles.

Main part numbers used on flexible silicone heaters

Part number	Temperature range °C (°F)	Capillary length (C, mm)	Bulb diameter (D, mm)	Bulb length (E, mm)	Max temperature on bulb °C (°F)
8CB030110AA60001	30-110°C (85-230°F)	250	6	90	140°C (284°F)
8CB050200AA60001	50-200°C (120-390°F)	250	6	67	230°C (446°F)

Accessories: Printed knobs

°C Printing		°F Printing	
30-110°C	50-200°C	85-230°F	120-390°F
66MZ0060301101FW	66MZ0060502001FW	66MZ0060502001FX	66MZ0060502001FX

Because of permanent improvement of our products, drawings, descriptions, features used on these data sheets are for guidance only and can be modified without prior advice



Contact us

Web: www.ultimheat.com

Cat25-2-8-7

Temperature sensors: **K thermocouple**, naked welding, for incorporation on flexible silicone heaters.

Temperature range	Cable insulation	Probe protection	Temperature sensing device	Signal type	Type
20- 200°C (120- 390°F)	FEP	Without	K thermocouple	Millivolts	TPR

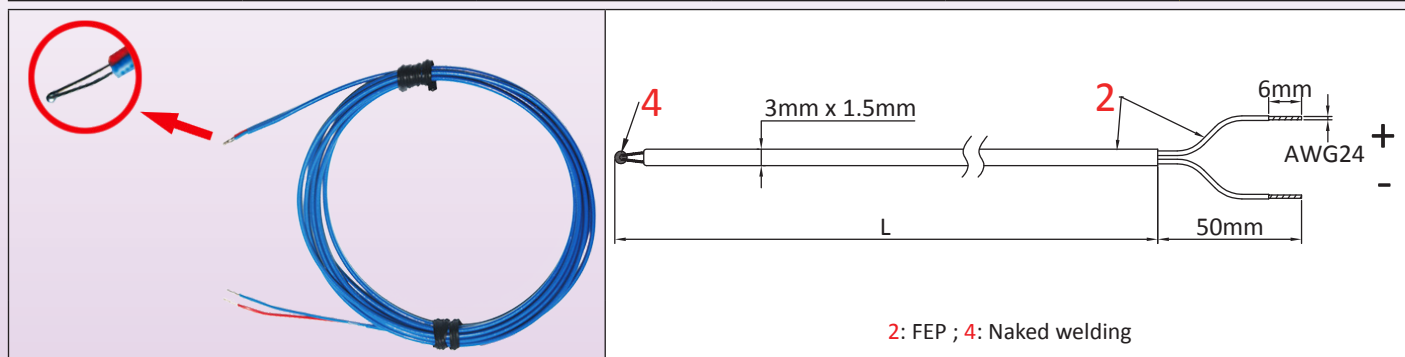

Main applications

The main advantage of these thermocouples in the temperature measurement of flexible heating elements is their small size and fast response. The welding of the thermocouple takes up little space and has a very low mass. They can be integrated into the heating elements without significantly increasing their thickness and without modifying their flexibility. They are resistant to shocks and vibrations.

Main Features

A thermocouple consists of two different metal wires soldered at one end. When heated, the solder generates a thermoelectric potential proportional to the temperature. This signal is used by electronic temperature controllers. Thermocouples are simple, but they need special connecting cables and a cold junction compensation system. Consequently, the electronic regulators using them are more complicated to produce than those using platinum thermistor or thermistor sensors.

Construction: The two conductors of the thermocouple are welded under a controlled atmosphere, in order to form a spheroidal weld, of small dimension (about 0.6 mm of diameter). It is this weld, which remains bare in this version, which measures the temperature.

Mounting: The end with the weld is then attached to the flexible heating element with a protective cap type 9BFS2, 9BFS7, 9BFM3 (see technical pages on silicone caps), which can be vulcanized or bonded.

Temperature range: Use temperature limited to 200°C due to FEP insulated cable.

Accuracy and tolerances: $\pm 2.5^\circ\text{C}$ between -40°C and 333°C (According to EN 60584-1 and 2 and IEC 584-1 and 2, for accuracy class 2)

Color code (according to DIN 43714): Red = positive, blue = negative, blue cable sleeving.

Cable composition: 2 rigid conductors, dia 0.3 mm, 200°C FEP insulation

Main part numbers

Part numbers	Wire length (mm)
TPR00060W02002F4	200
TPR00060W05002F4	500
TPR00060W10002F4	1000
TPR00060W20002F4	2000
TPR00060W30002F4	3000

Note: These temperature sensors are not manufactured by Ultimheat, and the information given is that of our suppliers.

Because of permanent improvement of our products, drawings, descriptions, features used on these data sheets are for guidance only and can be modified without prior advice



Temperature sensors: Encapsulated 100 Ohms platinum RTD for incorporation on flexible silicone heaters.

Temperature range	Cable insulation	Probe protection	Temperature sensing device	Signal type	Type
20- 200°C (120- 390°F)	FEP	Epoxy dipping	Pt100 platinum resistance	Ohms	TSO

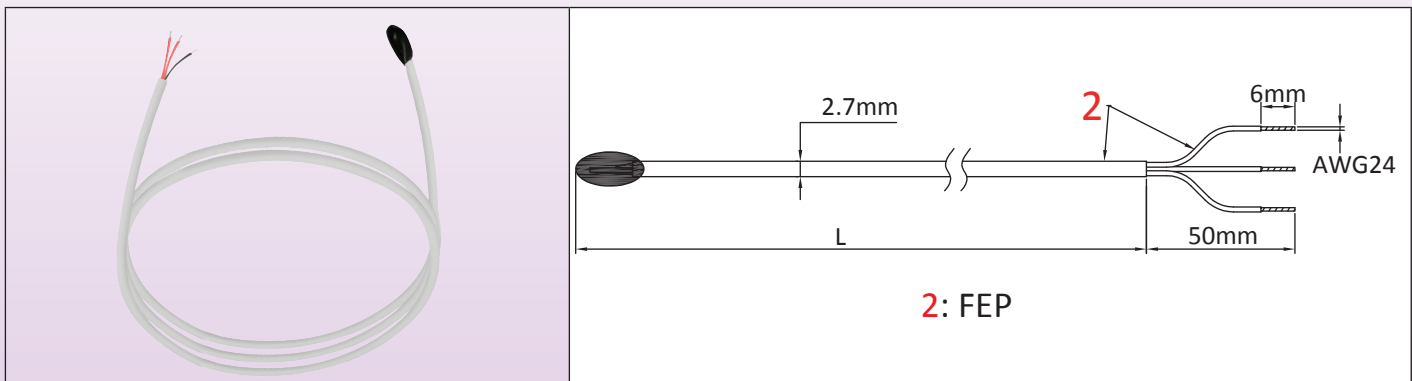

Main applications

The main advantage of these Pt100 sensors in the temperature measurement of flexible heating elements is their small size and fast response.

Due to their small dimensions, they can be glued to the surface of flexible heating elements under a protective cap. However they are significantly less resistant to shock and vibration than thermocouples, and are more expensive.

Main Features

The platinum resistivity has excellent repeatability, and high accuracy over a wide temperature range. The resistance variation curve of platinum as a function of temperature is much more linear than that of thermocouples or thermistors. Electronic controllers using Pt100 are simpler and less expensive than thermocouple ones.

In addition, they don't need temperature-compensated cable such as thermocouples. Pt100 are used worldwide and are interchangeable, using the DIN 43760 curve.

Construction: A platinum film is deposited on a ceramic substrate, conductors are welded to it, and the whole is encapsulated in an epoxy resin.

Mounting: The end with the Pt100 measuring element is then attached to the flexible heating element with a protective cap type 9BFM3 or 9BFV1, (see technical pages on silicone caps), which can be vulcanized or bonded.

Temperature range: Temperature limited to 200°C due to FEP insulated cable and epoxy used for encapsulation

Accuracy and tolerances:

- Nominal value at 0°C: 100 Ohms.
- Nominal value at 100°C: 138.51 Ohms

The international standard IEC 751-1983 and DIN EN 60751 2009-05 give the parameters of the temperature response curve.

Class B, the most common, has a tolerance of $\pm 0.3^\circ\text{C}$ at 0°C . ($\pm 0.12 \Omega$ at 0°C).

Color Code: The two red wires are connected together to their solder on one of the terminals of the ceramic substrate, and the white wire is connected to the other terminal.

- Section of the wires: $7 \times 0.15 \text{ mm}$.

Cable composition: 3 conductors, 0.12 mm^2 (AWG 24), FEP insulation 200°C , outside diameter 2.7 mm ($0.127''$).

- Diameter on conductor insulation: $0.95 \pm 0.5 \text{ mm}$.

- Wires gauge: $7 \times 0.15 \text{ mm}$.

Main parts numbers (Accuracy class B)

Part number	Cable length (mm)
TS040201W0200BD6	200
TS040201W0500BD6	500
TS040201W1000BD6	1000
TS040201W2000BD6	2000
TS040201W3000BD6	3000

Note: These temperature sensors are not manufactured by Ultimheat, and the information given is that of our suppliers.



Contact us

Web: www.ultimheat.com

Cat25-2-8-9

Temperature sensors: 100 Ohms platinum RTD, dia. 5mm x 30 mm stainless steel probe for incorporation on flexible silicone heaters.

Temperature range	Cable insulation	Probe protection	Temperature sensing device	Signal type	Type
20- 200°C (120- 390°F)	FEP	Stainless steel probe, dia.5mm x 30mm	Pt100 platinum resistance	Ohms, linear	TSR5

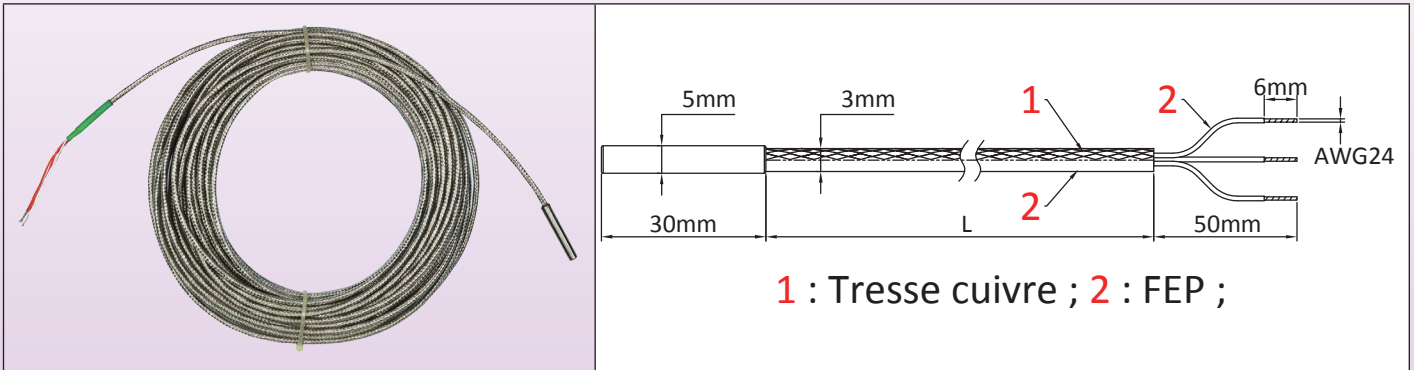

Main applications

The main advantage of these PT100 sensors in the temperature measurement of flexible heating elements is their robustness. Because of their small size, they can be glued or incorporated into flexible flat elements. They are resistant to shocks and vibrations, but their reaction time is longer, and they are more expensive than models with encapsulated measuring element.

Main features

The platinum resistivity has excellent repeatability, and high accuracy over an extended temperature range. The resistance variation curve of platinum as a function of temperature is much more linear than that of thermocouples or thermistors. Electronic controllers using Pt100 are simpler and less expensive than thermocouple ones. In addition, they do not need temperature-compensated cable such as thermocouples. Pt100 are used worldwide and are interchangeable, using the DIN 43760 curve.

Construction: A platinum film is deposited on a ceramic substrate, conductors are welded to it, and the whole is inserted in a stainless-steel protection probe.

Mounting: The end with the measuring element Pt100 is then fixed on the flexible heating element with a protective cap of type 9BFS3, 9BFM1, or 9BFV2 (see technical pages on the silicone caps), which can be vulcanised or glued.

Temperature range: Use temperature limited to 200°C due to FEP insulated cable.

Accuracy and tolerances:

- Nominal value at 0°C: 100 Ohms.
- Nominal value at 100°C: 138.51 Ohms

The international standard IEC 751-1983 and DIN EN 60751 2009-05 give the parameters of the temperature response curve.

Class B, the most common, has a tolerance of $\pm 0.3^\circ\text{C}$ at 0°C . ($\pm 0.12 \Omega$ at 0°C).

Color Code: The two red wires are connected together to their solder on one of the terminals of the ceramic substrate, and the white wire is connected to the other terminal.

Cable composition: 3 x 0.35 mm², (AWG24), FEP insulation + braid + FEP sleeving, T 200°C, O.D. 3 mm

Main parts numbers (Accuracy class B)

Part number	Cable length (mm)
TSR50030I0200BK6	200
TSR50030I0500BK6	500
TSR50030I1000BK6	1000
TSR50030I2000BK6	2000

Note: These temperature sensors are not manufactured by Ultimheat, and the information given is that of our suppliers.

Temperature sensors: 10 kohms NTC, dia. 6mm x 30 mm nickel plated copper probe for incorporation on flexible silicone heaters.

Temperature range	Cable insulation	Probe protection	Temperature sensing device	Signal type	Type
20- 120°C (68- 390°F)	FEP	Nickel plated copper probe, dia.6mm x 30mm	10 Kohms thermistor	Ohms Logarithmic	TNR6

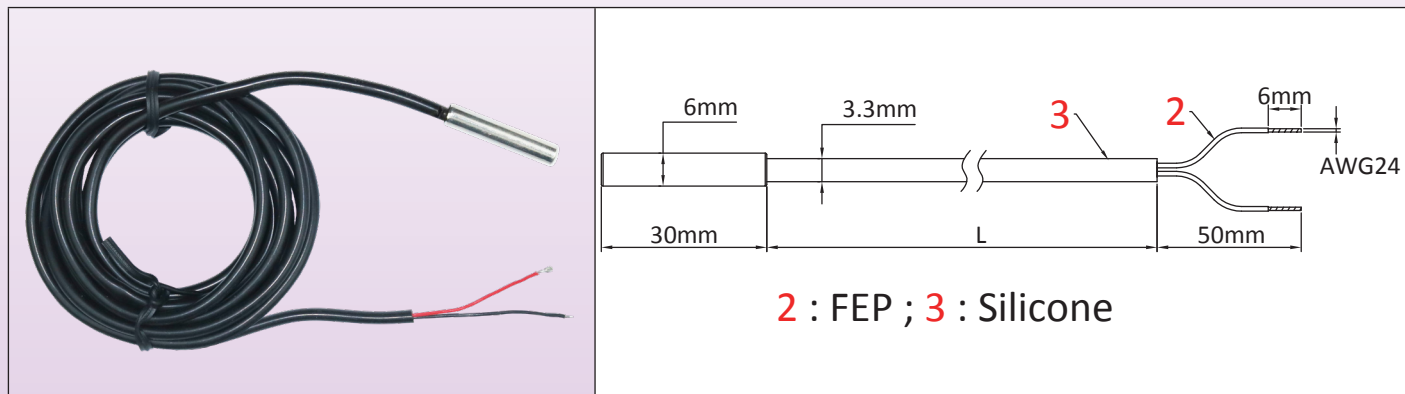

Main applications

The main advantage of these NTC sensors in the temperature measurement of flexible heating elements is their robustness and a relatively short response time. Because of their small size, they can be glued or incorporated into flexible flat elements. They are resistant to shocks and vibrations, but their temperature resistance is limited.

Main features

The thermistor is particularly economical. Its accuracy is correct for temperature ranges from 0 to 120°C. Its resistance decreases logarithmically with temperature. Its repeatability is good, but the interchangeability of the sensors between different suppliers is average. This is the reason why most electronic controllers using these thermistor sensors have a zero-correction system. These regulators are generally simple and inexpensive.

Construction: The measuring element is a glass bead encasing the sintered alloy with a negative temperature coefficient, from which two wires emerge. The conductors of the connecting cable are welded therein, and the assembly is inserted into a nickel-plated copper protection tube with low thermal inertia.

Mounting: The end with the NTC measuring element is then attached to the flexible heating element with a protective cap of type 9BFS4, 9BFM2 or 9BFV3 (see technical pages on silicone caps), which can be vulcanized or bonded.

Temperature range: The operating temperature is limited to 120 ° C.

Accuracy and tolerances:

- Nominal value at 25 ° C: 10 Kohms +/- 1%. B = 3380 +/- 1%

Color Code: The two conductors are identical in color and each corresponds to one of the terminals of the thermistor. Due to the high resistance of the measuring element, a third conductor is not necessary.

Composition of the cable: 2 x 0.35 mm², (AWG24) silicone insulation with FEP sleeving, outer diameter 3.3 mm.

Main parts numbers (accuracy class 1%)

Part number	Cable length (mm)
TNR60030C02001F4	200
TNR60030C05001F4	500
TNR60030C10001F4	1000
TNR60030C20001F4	2000
TNR60030C30001F4	3000

Note: These temperature sensors are not manufactured by Ultimheat, and the information given is that of our suppliers.

Because of permanent improvement of our products, drawings, descriptions, features used on these data sheets are for guidance only and can be modified without prior advice



Electronic thermostats, NTC sensor

Selection of part numbers used in flexible silicone heaters

Temperature range	Mounting	Adjustment	Sensor	Action type	Types
20-125°C (68-260°F)	Equipment board	Temperature printed knob	NTC thermistor	On-Off	2PE2N6

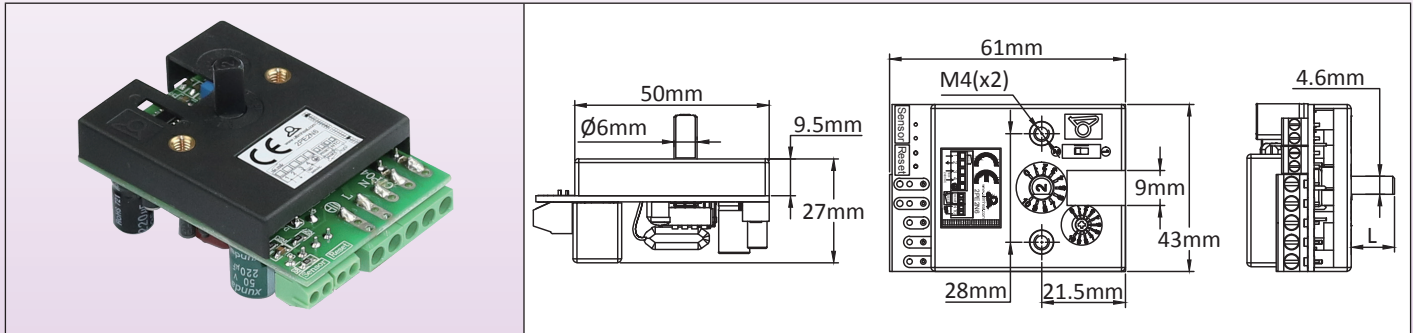

Applications principles

This electronic thermostat for incorporation has been designed to allow a distant temperature control of flexible silicone heaters. It is mounted with two screws M4 at the same distance 28 mm than bulb and capillary thermostats, uses a 6mm dia. shaft with 4.6mm flat, and its knob rotation angle is 230°. Its electrical rating is 16A 230V, identical to the electromechanical thermostats. **This is an economical solution, useful in catering equipment.**

Main features

Action: On-Off.

Size: 60 x 43 x 23 mm.

Temperature sensor: NTC thermistor, 10Kohms @25°C, B(25-50)= 3380

Temperature ranges: 20-125°C (68-260°F)

Temperature differential: Adjustable, by potentiometer with front access, from 0.5 to 5.5°C (0.9 to 10°F) for other temperature ranges.

Accuracy: +/-1% of scale (NTC sensor tolerances not included).

Power supply: 180 to 240V, 50Hz or 60Hz.

Relay output: 16A250V resistive, 100000 cycles.

Relay action: open on temperature rise

Ambient: -20+50°C, 10-85% RH.

Power: <2W

Electrical connections:

- Power supply and power relay: 2.5 mm² screw terminal block

-Temperature sensor: 1.5 mm² screw terminal block

Adjustment shaft: The thermostat is shipped with a dia. 6mm with 4.6 mm flat shaft, length 11 mm, assembled. Included is also a set of: one 15mm shaft, one 28 mm shaft and one screw driver adjustment shaft.

Options: Available with many other temperature ranges. Also available with manual reset action (Ask for full technical data sheet)

	<ol style="list-style-type: none"> 1: Cover 2: Printed circuit 3: Elastic washer 4: Screw driver shaft 5: 11 mm shaft fitted in standard 6: 15 mm shaft 7: 28 mm shaft 8: Shaft bearing 9: Plastic spacer 10: Cover screws, (unscrew to change shaft length) 	<p>Standards: Comply with LVD and EMC (CE certificate by TÜV), upon the following standards: EN55014-1: 2006+A1+A2; EN55014-2: 1997+A1+A2; EN61000-3-2:2014; EN61000-3-3: 2013; EN60730-1:2011; EN60730-2-9: 2010, and ROHS compliance certificate.</p>
Reference: 2PE2N6		

Soft grip printed knobs references

(Must be ordered separately, not included in the electronic thermostat)

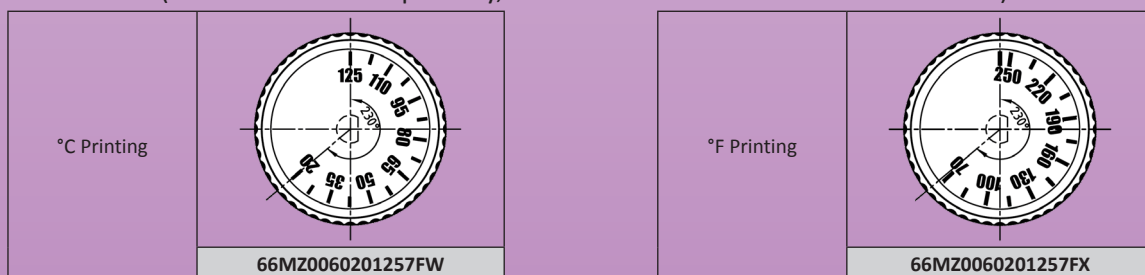

Because of permanent improvement of our products, drawings, descriptions, features used on these data sheets are for guidance only and can be modified without prior advice



Electronic thermostats, **Pt100 RTD sensor** Selection of part numbers used in flexible silicone heaters

Temperature range	Mounting	Adjustment	Sensor	Action type	Types
50-200°C (120-390°F)	Equipment board	Temperature printed knob	Pt100 RTD sensor	On-Off	2PE2P6

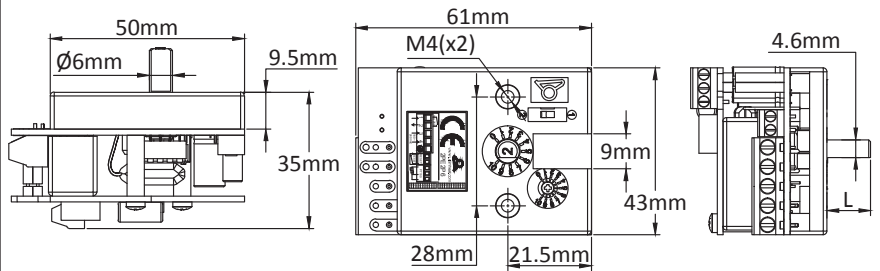

Applications principles

This electronic thermostat for incorporation has been designed to allow a distant temperature control of flexible silicone heaters. It is mounted with two screws M4 at the same distance 28 mm than bulb and capillary thermostats, uses a 6mm dia. shaft with 4.6mm flat, and its knob rotation angle is 230°. Its electrical rating is 16A 230V, identical to the electromechanical thermostats. **This is an economical solution, useful in catering equipment.**

Main features

Action: On-Off.

Size: 61 x 43 x 35 mm.

Temperature sensor: Pt100

Temperature range: 50-200°C (120-390°F)

Temperature differential: Adjustable, by potentiometer with front access, from 0.5 to 5.5°C (0.9 to 10°F) for other temperature ranges.

Accuracy: +/-1% of scale (NTC sensor tolerances not included).

Power supply: 180 to 240V, 50Hz or 60Hz.

Relay output: 16A250V resistive, 100000 cycles.

Relay action: open on temperature rise

Ambient: -20+50°C, 10-85% RH.

Power: <2W

Electrical connections:

- Power supply and power relay: 2.5 mm² screw terminal block

- Temperature sensor: 1.5 mm² screw terminal block

Adjustment shaft: The thermostat is shipped with a dia. 6mm with 4.6 mm flat shaft, length 11 mm, assembled. Included is also a set of: one 15mm shaft, one 28 mm shaft and one screw driver adjustment shaft.

Options: Available with many other temperature ranges. Also available with manual reset action (Ask for full technical data sheet)

	<ol style="list-style-type: none"> 1: Cover 2: Main printed circuit board 3: Elastic washer 4: Screw driver shaft 5: 11 mm shaft fitted in standard 6: 15 mm shaft 7: 28 mm shaft 8: Shaft bearing 9: Plastic spacer 10: Cover screws, (unscrew to change shaft length) 11: Pt100 input printed circuit board 	<p>Standards: Comply with LVD and EMC (CE certificate by TÜV), upon the following standards: EN55014-1:2006+A1+A2; EN55014-2: 1997+A1+A2; EN61000-3-2:2014; EN61000-3-3:2013; EN60730-1:2011; EN60730-2-9:2010, and ROHS compliance certificate.</p>
Part number: 2PE2P6		

Soft grip printed knobs and bezels part numbers

(Must be ordered separately, not included in the electronic thermostat)

°C Printing	°F Printing	Black ABS bezel	Chrome plated ABS Bezel
<p style="text-align: center;">66MZ0060502001FW</p>	<p style="text-align: center;">66MZ0060502001FX</p>	<p style="text-align: center;">66EN1</p>	<p style="text-align: center;">66EN3</p>

Because of permanent improvement of our products, drawings, descriptions, features used on these data sheets are for guidance only and can be modified without prior advice



Contact us

Web: www.ultimheat.com

Cat25-2-8-13

Electronic temperature controllers, Din rail mounting **NTC or Pt100 RTD sensor**

Selection of part numbers used in flexible silicone heaters

Temperature range	Mounting	Adjustment	Sensor	Action type	Types
-30+200°C (-20+390°F)	On Din rail	Digital	NTC thermistor or Pt100 RTD	On-Off	2DNA

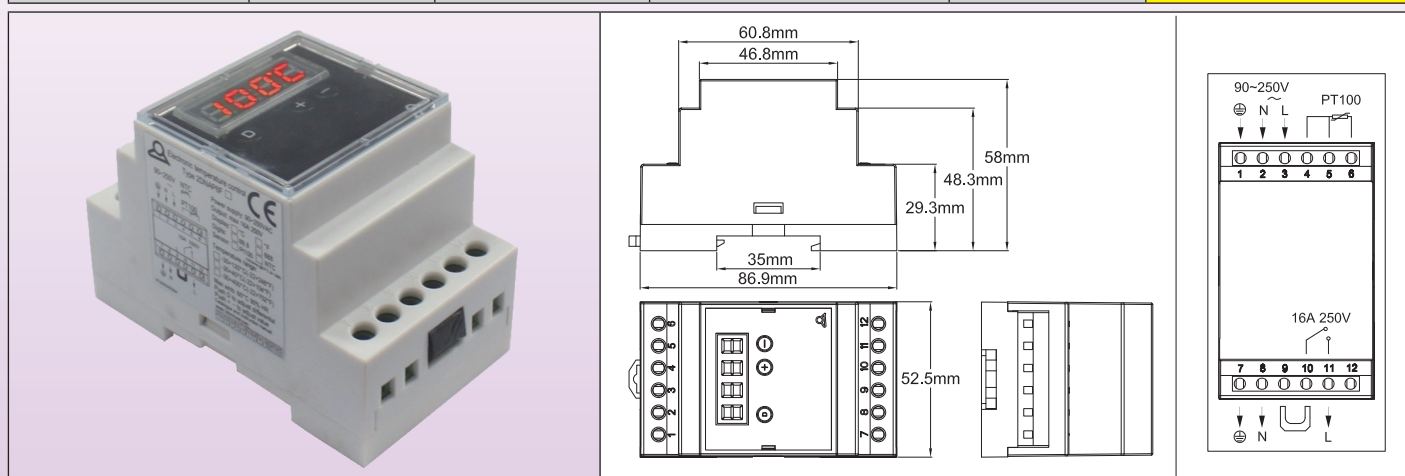

Applications

This electronic temperature controller with **the simplest and the most instinctive setting by end user** was designed for easy incorporation inside cabinets with DIN rail mounting. It can be used by untrained operators.

It provides simple On Off action temperature control.

End user has access to set point and differential setting only.

Adjustment of maximum temperature can be set.

Main features

Dimensions: 86.9 x 58 x 52.5 mm

Display: 3+1 digit LED. The fourth digit is used to display °C or °F

Set point setting: In normal use, the display shows the measured temperature. Push “+” or “-” keys will display the set point value, and at that time it can be adjusted with “+” and “-” keys. No action during 5 seconds will register the new set point value and bring back display to measured value.

Temperature differential setting: In normal use, the display shows the measured temperature. Push “D” key will display the differential value, at that time it can be adjusted with “+” and “-” keys. Push “D” again or no action during 5 seconds will register the new differential value and bring back display to the measured value.

Action: On-Off

Temperature sensor: Pt100 (2 or 3 wires) or NTC 10Kohms @25°C, B= 3380 (2 wires).

Accuracy: +/-1% of scale

Temperature adjustment ranges:

-30+120°C (-20+250°F), with 1° display

-30+200°C (-20+390°F), with 1° display

Power supply: 90 to 240V, 50Hz or 60Hz

Relay output: 16A 250V res., 100,000 cycles. Output Led displays relay position.

Maximum possible set point adjustment by user: Push “D” button more than 10 seconds, display shows the maximum temperature that can be set by the user. Then it is possible to adjust this value with “+” and “-”. Push again on “D” or do nothing during 5 seconds will register the maximum possible setting value and control will come back to the measured valued.

Ambient: -20+60°C, 10-90% RH

Power: <4W

Fail safe safety:

- If no power supply, relay output contact will open
- If Pt100 sensor or NTC is broken or not connected properly, relay output contact will open and display will show “EEE”
- If measured temperature is higher than allowed by the set range, display will show HHH
- If measured temperature is lower than -30.0°C or -20.0°F, display will show LLL.

Electrical connections:

-Power input: Neutral, phase, ground, with 2.5 mm² terminals

-Power output: Neutral, phase, ground, with 2.5 mm² terminals for direct connection to the load.

-Temperature sensor: three 2.5 mm² screw terminal

One removable jumper provides a potential free relay output for applications needing a separate circuit for relay, external timer or other.

Standards: Comply with LVD, EMC (CE certificate by TUV), ROHS and Reach.

Because of permanent improvement of our products, drawings, descriptions, features used on these data sheets are for guidance only and can be modified without prior advice



Main references

References	Temperature range	Sensor	Display
2DNAP6FA	-30+120°C	NTC	°C
2DNAP6FB	-20+250°F	NTC	°F
2DNAP6FI	-30+200°C*	Pt100	°C
2DNAP6FJ	-20+390°F*	Pt100	°F

* It is possible to unlock this value up to 400°C (750°F)

Because of permanent improvement of our products, drawings, descriptions, features used on these data sheets are for guidance only and can be modified without prior advice



77 x 35mm electronic temperature controllers, digital display, panel mounting, **NTC, Pt100 RTD or K thermocouple sensor**

Selection of part numbers used in flexible silicone heaters

Temperature range	Mounting	Adjustment	Sensor	Action type	Types
-30+200°C (-20+390°F)	Panel mounting in 71x29mm cut-out	Digital	NTC thermistor or Pt100 RTD or K thermocouple	On-Off	273

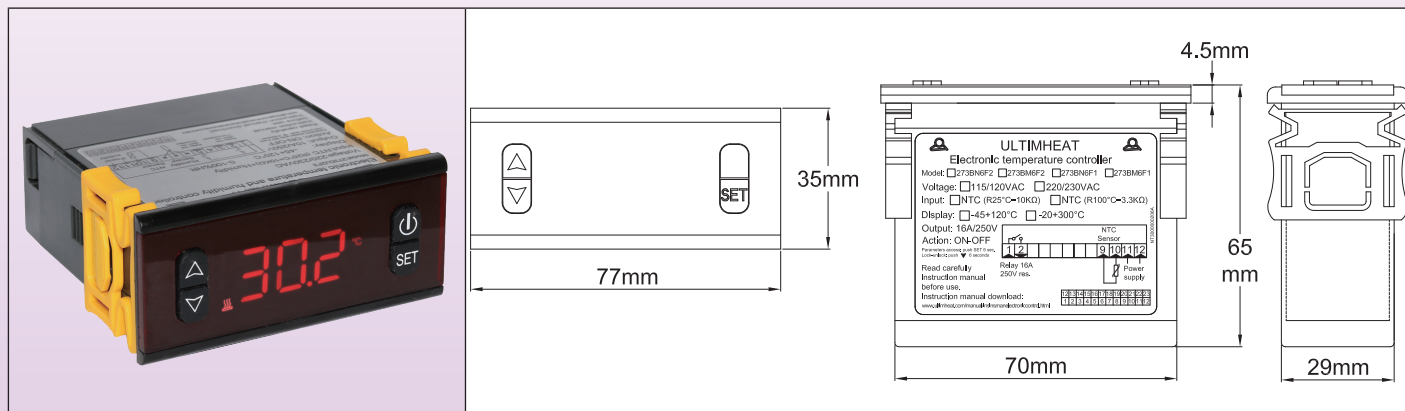

Applications

This electronic temperature controller with **the simplest and the most instinctive setting by end user** was designed for easy incorporation on control panels. It has a very simple user interface with a set point change without password, using the "up" and "down" keys. It can be used by untrained operators.

End user has access to set point and differential setting.

Main features

Dimensions: 77 x 35 x 60mm. Board hole cutting * 71x29mm.

Compatible temperature sensors:

-The model with NTC input, uses a thermistor with R @ 25 °C value: 10KΩ (± 1%), B @ 25/50 °C: 3380KΩ (± 1%).

-Pt100 and thermocouple K.

Action: On-Off with adjustable differential.

Output: Relay with 16A or 10A resistive resistive according to models.

Alarm: 5A alarm relay on K thermocouple model.

Display: In °C

Power supply: AC 220-230V 50-60Hz

Accuracy: ± 1°C (± 2°F) or 0.3% end scale ± one digit.

Auto test: Alarm display of off high or low scale, and open sensor circuit detection.

Ambient: temperature from -10 to 60°C, relative humidity from 20 to 85%, non-condensing.

Resolution: 1° (0.1° in the range - 19.9° to 99.9° for the model -45 + 120 °C)

Main part numbers (230V models)

Part numbers	Température rang	Sensor	Rating of the main output relay
273BN6F2	-45+120°C	NTC	16A
273BPOF2	-150+550°C	Pt100	10A
273BK1F2	0-999°C	K	10A

Wiring

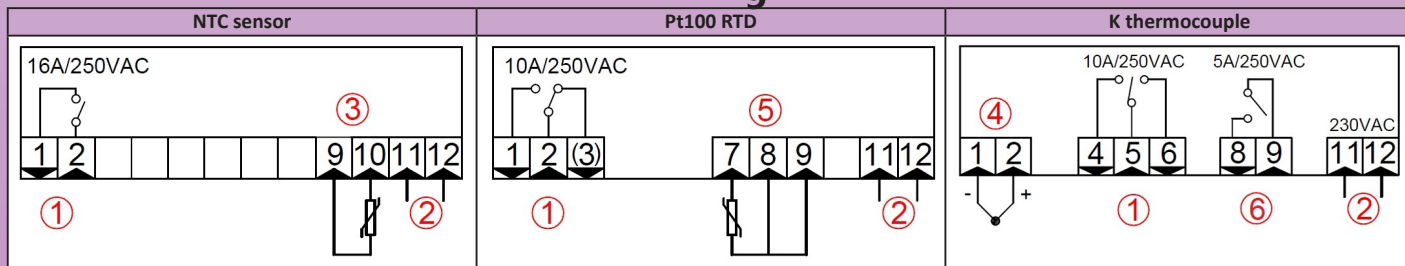

1: Relay output; 2: 230V AC power supply; 3: NTC sensor; 4: K thermocouple sensor; 5: Pt100 sensor; 6: Alarm relay output.

Because of permanent improvement of our products, drawings, descriptions, features used on these data sheets are for guidance only and can be modified without prior advice



48 x 48mm electronic temperature controllers, double digital display, PID action, panel mounting, **Pt100 RTD or K thermocouple sensor**

Selection of part numbers used in flexible silicone heaters

Temperature range	Mounting	Adjustment	Sensor	Action type	Types
Configurable	Panel mounting in 45x45mm cut-out	Digital	Pt100 RTD or K thermocouple	PID or On-Off	244

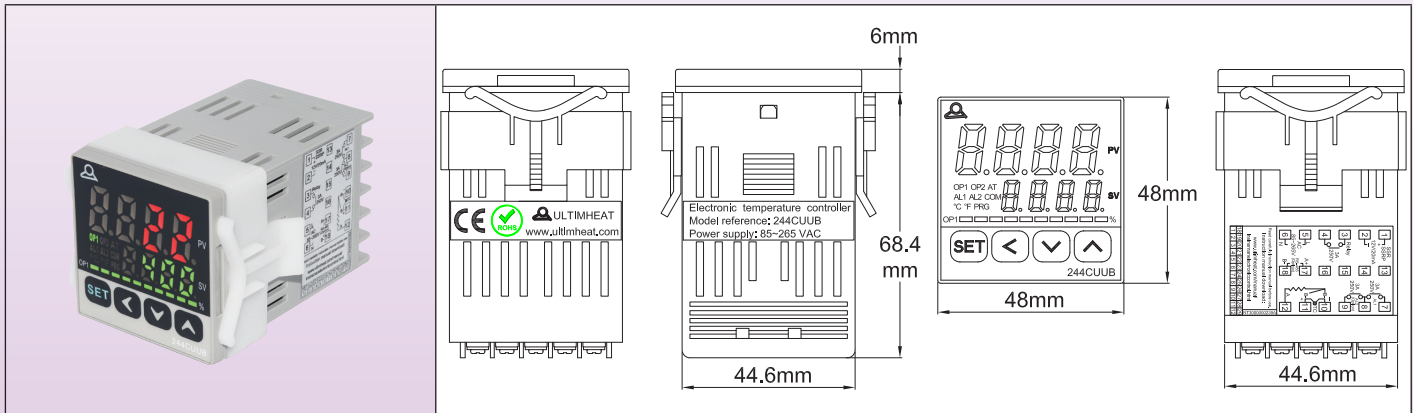

Applications

This electronic controller, designed to be **the most universal**, is intended to be integrated into control panels. It is totally configurable. Its use requires reading and understanding of its instructions.

Its small size makes it easy to integrate, and the auto-tune function allows automatic adjustment of PID parameters. The incorporation of a microprocessor using Fuzzy Logic technology makes it possible to reach a predetermined setpoint as quickly as possible, with a minimum of overheat during disturbances related to the ramp-up or the external load.

The electromechanical relay and static relay outputs are standard.

The temperature sensor input is configurable, and in particular allows the **use of Pt100 and thermocouple K sensors of flexible silicone heating elements.**

Main features

Dimensions: 48 x 48 x 74.4mm, Panel cut-out: 45 x 45 mm.

Input: Pt 100 and thermocouples K, T, R, J, B, S, E.

Output: Relay output or voltage pulse for SSR.

Output percentage indication: with graphic LED bar.

Alarm: 1 alarm relay in standard. Second alarm in option.

Operation: auto-tune function sets automatically the PID parameters to the system characteristics.

Power supply voltage: AC 85~265V 50-60Hz.

Power: <6W.

Output Specifications:

- Main Control Output: 1 relay, heating or cooling selectable,
- Contact Rating (SPST): 3A, 250Vac Res.
- Alarm output: 3A, 250Vac Res.
- SSR drive: 12V DC (20mA).

Accuracy: 0.3% end of scale.

Ambient temperature: 0 to 50°C, 0 to 95% RH.

Part number	244CUUB

Wiring diagram

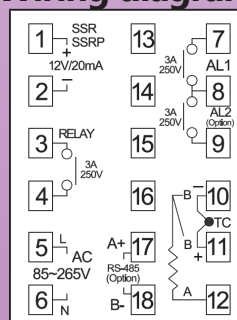

Because of permanent improvement of our products, drawings, descriptions, features used on these data sheets are for guidance only and can be modified without prior advice



Contact us

Web: www.ultimheat.com

Cat25-2-8-17

IP65 fixed setting antifreeze thermostat, 2 cable gland outputs, two pilot lights

(Selection of models usable on silicone heating elements).

Temperature range	Electric rating	Contact style	Temperature sensing device	Temperature setting	Types
3~10°C 37.4~50°F	8 to 16A	Snap action	Bimetal	Fixed setting	Y22

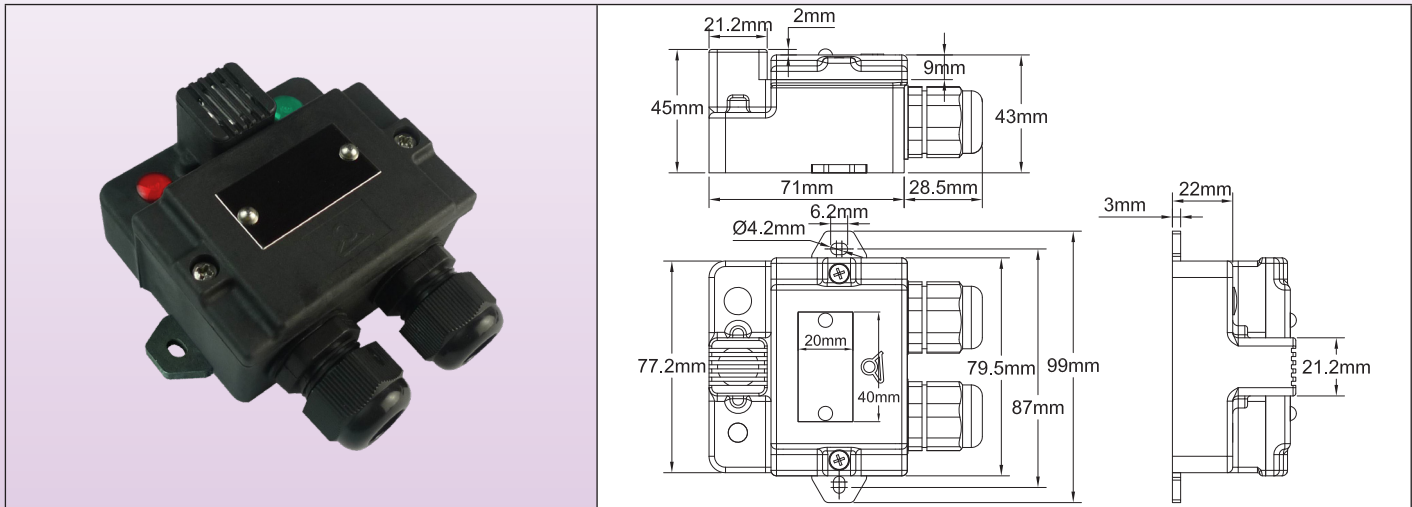

Applications

Prevention against freezing, activation of defrost or heating system.

In these boxes, the thermostat, bimetal disc type, is over-molded, and is thermally insulated from the wall on which it is mounted. Its temperature sensing cup is mechanically protected by a grid. It is located in front of the enclosure to be in an area of natural circulation of air. It can therefore be used outdoors, for the control of silicone heating ribbons without antifreeze thermostat, in the protection of water meters, water tanks, pipes, livestock waterers, etc.

Mounting: On wall, by external side brackets. These tabs can be folded inwards. A knockout hole allows electrical connection through the backside. (Note: in this case the ingress protection class IP65 is lost).

Protection against water and dust ingress: IP65

Protection against shocks: IK03 on thermostat guard, IK10 the rest of the housing.

Material: Black PA66, glass-fiber reinforced

Screws: Stainless steel, captives

Output: 2 Cable glands M20, PA66, IP66, for cables diameter from 6 to 12 mm.

Electrical rating: Single pole, 8 to 16A 250V (100000 cycles). Contact opens on temperature rise. 230V neutral and line power supply is requested.

Pilot lights: Visualize the power supply and thermostat contact position.

Connection: Built in 4mm² screw terminal block.

Options:

- Other calibration temperatures
- 115V pilot lights

Customization: On request (MOQ apply).

Contact open temperature °C (°F)	Contact close temperature °C (°F)	Electric rating	Part numbers
8°C / (46.4°F)	3°C (37.4°F)	8A 250V	Y22D9Z00805HCSV0
10°C (50°F)	4°C (39.2°F)	10A 250V	Y22D9P01006CUSV0
10°C (50°F)	4°C (39.2°F)	16A 250V	Y22D9J01006CUSV0

Because of permanent improvement of our products, drawings, descriptions, features used on these data sheets are for guidance only and can be modified without prior advice



Digital display temperature control box, On-Off action, **NTC** sensor, for temperature control of flexible silicone heaters

Temperature ranges	Mounting	Adjustment	Sensor	Action type	Types
- 45 + 120°C / (- 49 + 250°F) - 150 + 550°C / (- 238 + 1022°F) 0 - 999°C / (32 - 1830°F)	Wall mounting	Digital	NTC thermistor or Pt100 RTD or K thermocouple	On-Off	Y8WH



Model with 5 ways waterproof connector

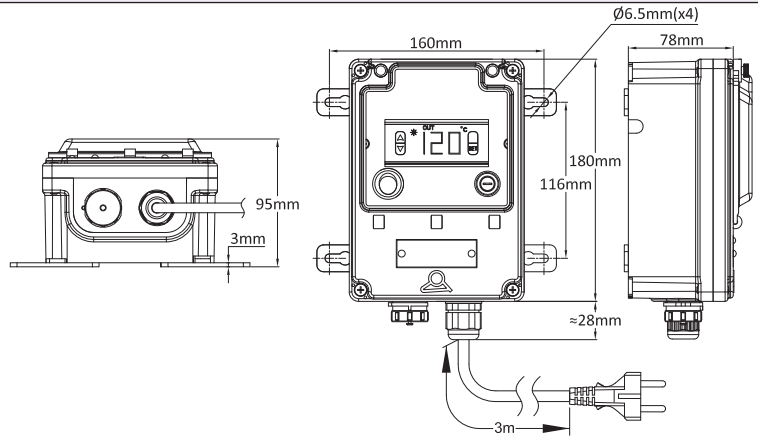

Model with 5 ways waterproof connector



Model with 3 cable glands

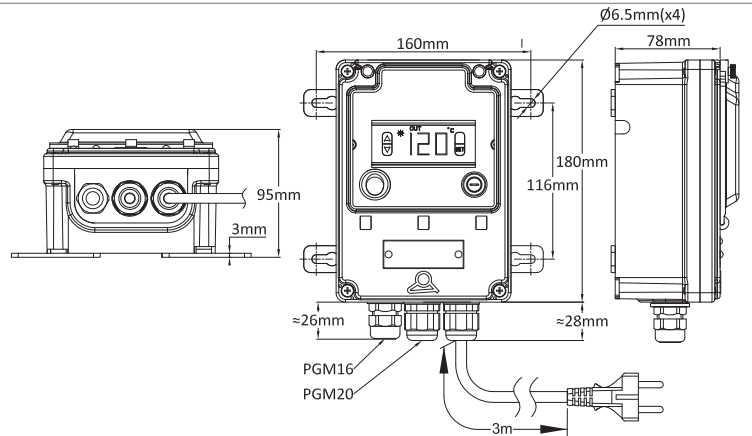

Model with 3 cable glands

Applications

These waterproof control boxes allow remote control of the temperature of the flexible heating elements. This model is easy to use and is not intended for specially trained users. Models with 5-way connector can accept all models of our range with a cord having a connector, provided that the temperature sensors are identical. The models with 3 cable glands can be used on all versions without connectors, also provided that the temperature sensors are identical.

Main features

- Enclosure:** IP69K, reinforced PA66, with polycarbonate window access. Sealable cover and window.
- Wall mounting:** Four removable and rotatable legs.
- Electrical connection:** On internal connection block.
- Switching devices:** Main power illuminated switch and safety fuse.
- Controller:** With very simple end-user interface. Change of set point is made without password, with up and down keys.
- Action:** On-Off with adjustable differential.
- Sensor input:** NTC, R@25°C:10 Kohms (±1%), B@25/50°C: 3380 Kohms (±1%), K thermocouple or Pt100 depending of models.
- Power output:** 10 or 16A 230V res. relay, depending of models.
- Display:** 3 digits
- Power supply:** AC 220-230V 50-60Hz.
- Accuracy:** ±1°C (±2°F) or 0.3% end of scale ± one digit.
- Self-testing:** Over-scale, under-scale, and open sensor circuit.
- Ambient temperature:** -10 to 60°C, 20 to 85% relative humidity, non-condensing.
- Temperature display range:** see part numbers table

Because of permanent improvement of our products, drawings, descriptions, features used on these data sheets are for guidance only and can be modified without prior advice



Contact us

Web: www.ultimheat.com

Cat25-2-8-19

Digital display temperature control box, On-Off action, **NTC** sensor, for temperature control of flexible silicone heaters

Main part numbers (230V models, cord with euro plug) *

Part numbers	Temperature ranges	Sensor	Rating of the main output relay	Output to the flexible heating element
Y8WHQ02101000AUV	-45+120°C (-49+250°F)	NTC	16A	By 5 terminals waterproof connector
Y8WHS02101000AUV	-150+550°C (-238 +1022°F)	Pt100	10A	By 5 terminals waterproof connector
Y8WHS02181000DUV	--150+550°C (-238 +1022°F)	Pt100	16A**	By 5 terminals waterproof connector
Y8WHT02101000AUV	0-999°C (32-1830°F)	K	10A	By 5 terminals waterproof connector
Y8WHT02181000DUV	0-999°C (32-1830°F)	K	16A**	By 5 terminals waterproof connector
Y8WHQ02101000AUQ	-45+120°C (-49+250°F)	NTC	16A	By one M20 cable gland for power, and one M16 cable gland for temperature sensor
Y8WHS02101000AUQ	-150+550°C (-238 +1022°F)	Pt100	10A	By one M20 cable gland for power, and one M16 cable gland for temperature sensor
Y8WHS02181000DUQ	--150+550°C (-238 +1022°F)	Pt100	16A**	By one M20 cable gland for power, and one M16 cable gland for temperature sensor
Y8WHT02101000AUQ	0-999°C (32-1830°F)	K	10A	By one M20 cable gland for power, and one M16 cable gland for temperature sensor
Y8WHT02181000DUQ	0-999°C (32-1830°F)	K	16A**	By one M20 cable gland for power, and one M16 cable gland for temperature sensor

* UL plug: replace the last character Q by R or V by U

** : These products have an additional 16A relay board

Because of permanent improvement of our products, drawings, descriptions, features used on these data sheets are for guidance only and can be modified without prior advice



Double digital display temperature control box, PID action, for temperature control of flexible silicone heaters

Temperature ranges	Mounting	Adjustment	Sensor	Action type	Types
Configurable	Wall mounting	Digital	Configurable	PID	Y8WJ

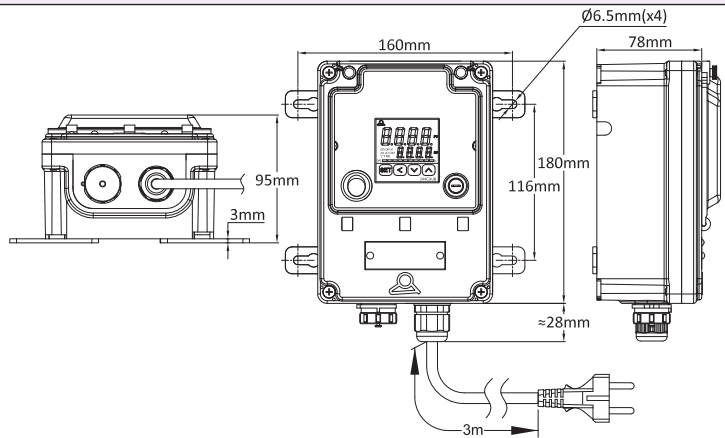

Model with 5 ways waterproof connector

Model with 5 ways waterproof connector

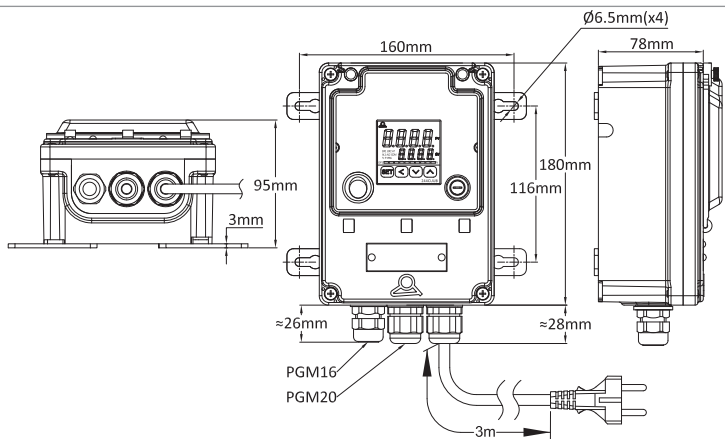

Model with 3 cable glands

Model with 3 cable glands

Applications

These waterproof control boxes allow remote control of the temperature of the flexible heating elements. This electronic controller used is designed to be **the most universal**, is intended to be integrated into control panels. It is totally configurable. **Its use requires reading and understanding of its instructions.** It includes an auto-tune function allowing automatic adjustment of PID parameters. The incorporation of a microprocessor using Fuzzy Logic technology makes it possible to reach a predetermined setpoint as quickly as possible, with a minimum of overheat during disturbances related to the ramp-up or the external load. A 20A 250V solid state relay board is included in standard. The temperature sensor input is configurable, and in particular allows the **use of Pt100 and thermocouple K sensors of flexible silicone heating elements.**

Models with 5-way connector can accept all models of our range with a cord having a connector, provided that the temperature sensors are identical. The models with 3 cable glands can be used on all versions without connectors, also provided that the temperature sensors are identical.

Main features

Enclosure: IP69K, reinforced PA66, with polycarbonate window access. Sealable cover and window.

Wall mounting: Four removable and rotatable legs.

Electrical connection: With 5 ways waterproof connector, or on internal connection block for 3 cables gland model. With 3 meters power supply cord, 3x1.5mm², rubber insulated, euro plug (UL plug in option).

Switching devices: Main power illuminated switch and safety fuse.

Controller: Double display, of process value and of set-point

Action: PID with automatic parameters adjustment by auto-tune function.

Sensor input: configurable for Pt100, K thermocouple and other sensors

Because of permanent improvement of our products, drawings, descriptions, features used on these data sheets are for guidance only and can be modified without prior advice



Contact us

Web: www.ultimheat.com

Cat25-2-8-21

Double digital display temperature control box, PID action, for temperature control of flexible silicone heaters

Power output: 20A 230V solid state relay.

Alarm: 3A 230V relay.

Display: 4 digits display configurable in °C or °F

Power supply: AC 220-230V 50-60Hz.

Accuracy: ±1°C (±2°F) or 0.3% ES± one digit.

Self-testing: open sensor circuit.

Ambient temperature: -10 to 60°C, 20 to 85% relative humidity, non-condensing.

Temperature display range: Configurable

Resolution: 0.1°.

Main part numbers usable on flexible heating elements (230V models)

Part number of the model with 5 ways connector, euro plug cord	Part number of the model with 3 cable glands, euro plug cord. (One M20 cable gland for power output, one for power supply cord and one M16 for the temperature sensor)	Part number of the model with 5 ways connector, UL plug cord	Part number of the model with 3 cable glands, UL plug cord. (One M20 cable gland for power output, one for power supply cord and one M16 for the temperature sensor)
Y8WJU021D1000FUV	Y8WJU021D1000FUS	Y8WJU021D1000FUU	Y8WJU021D1000FUT

Because of permanent improvement of our products, drawings, descriptions, features used on these data sheets are for guidance only and can be modified without prior advice



Mounting accessories for flexible silicone heaters













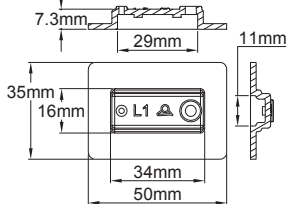

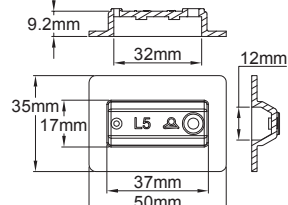

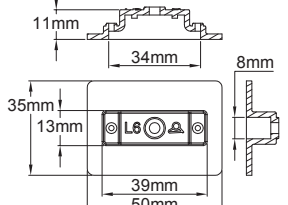

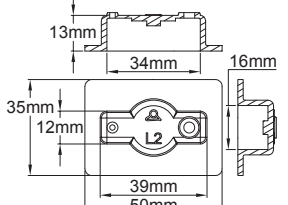
Silicone boots for mounting **fixed setting limiters or thermostats** on flexible silicone heaters. Assembly by bonding or vulcanization.

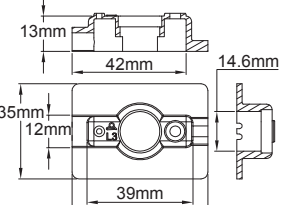
Type

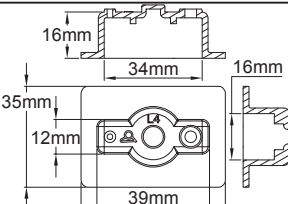
9BFL

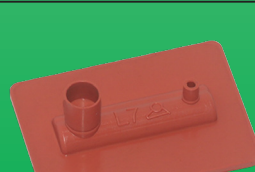
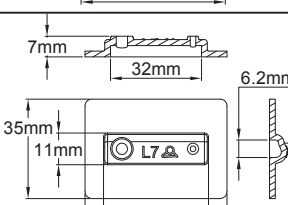
These boots comprise a degassing orifice and a «funnel» orifice for filling the silicone resin, which are cut after curing.

Type	Dimensions	Compatible devices	Features	Part number
		 UJW	Minimum band width: 35mm Connection: internal Silicone resin filling: yes	9BFL1
		 4A	Minimum band width: 35mm Connection: internal Silicone resin filling: yes	9BFL5
		 4T	Minimum band width: 35mm Connection: internal Silicone resin filling : no	9BFL6
		 4903	Minimum band width: 35mm Connection: internal Silicone resin filling: yes	9BFL2
		 4903	Minimum band width: 35mm Connection: external by 2 wires Silicone resin filling: yes	9BFL3
		 4505	Minimum band width: 35mm Connection: internal Silicone resin filling: partial	9BFL4
		 5MA3	Minimum band width: 35mm Connection: internal Silicone resin filling: yes	9BFL7

Because of permanent improvement of our products, drawings, descriptions, features used on these data sheets are for guidance only and can be modified without prior advice



Contact us

Web: www.ultimheat.com









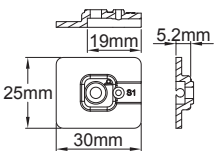

Cat25-2-9-3

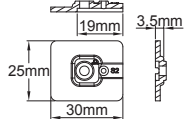
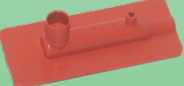
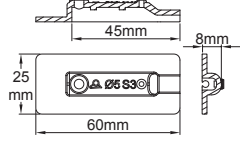
Silicone boots for mounting of **temperature sensors and thermostats bulbs** on flexible silicone heaters surface. Assembly by bonding or vulcanization.

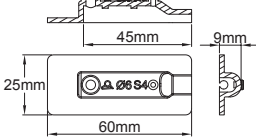
Type

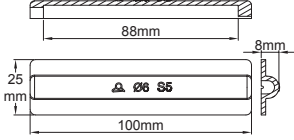
9BFS

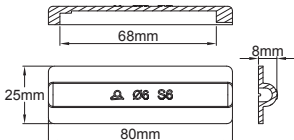
Some of these boots comprise a degassing orifice and a «funnel» orifice for filling the silicone resin, which are cut after curing.

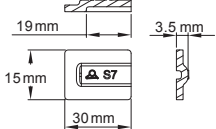
Type	Dimensions	Compatible devices	Features	Part number
		Flat RTD	Minimum band width: 25mm Connection: external sensor cable Silicone resin filling: yes	9BFS1
		Naked welding thermocouple or glass bead thermistor	Minimum band width: 25mm Connection: external sensor cable Silicone resin filling: yes	9BFS2
		Temperature sensor dia. 5mm, 30mm maximum length	Minimum band width: 25mm Connection: external sensor cable Silicone resin filling: yes	9BFS3
		Temperature sensor dia. 6mm, 30mm maximum length	Minimum band width: 25mm Connection: external sensor cable Silicone resin filling: yes	9BFS4
		Temperature sensor dia. 6mm or thermostat bulb dia. 6mm, maximum length 88mm	Minimum band width: 25mm Connection: external sensor cable or capillary Silicone resin filling: possible	9BFS5
		Temperature sensor dia. 6mm or thermostat bulb dia. 6mm, maximum length 68mm	Minimum band width: 25mm Connection: external sensor cable or capillary Silicone resin filling: possible	9BFS6
		Naked welding thermocouple or glass bead thermistor	Minimum band width: 15mm Connection: external sensor cable or capillary Silicone resin filling: possible	9BFS7

Because of permanent improvement of our products, drawings, descriptions, features used on these data sheets are for guidance only and can be modified without prior advice







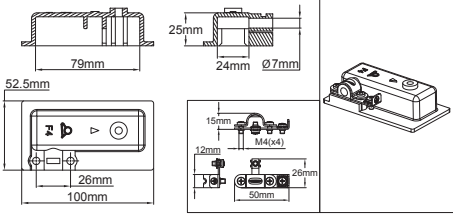
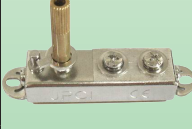

Silicone enclosures for mounting of **adjustable thermostats** on flexible silicone heaters surface. Assembly by bonding or vulcanization.

Type

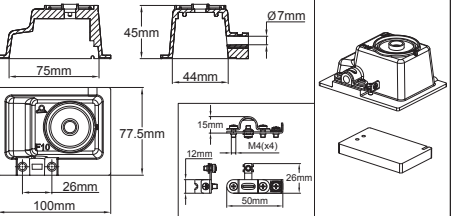
9BFF

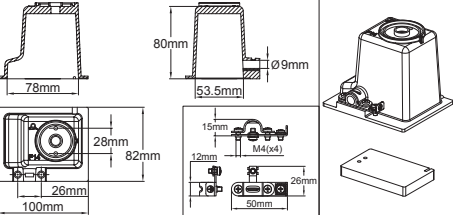
These enclosures include a stainless-steel removable locking device for the power cable and an internal and external grounding terminal. Some models also include a thick insulating silicone foam pad to thermally insulate the thermostat body from the temperature of the heater. The models for bulb and capillary thermostat have a lateral outlet for the capillary. The flexibility of the silicone makes it possible to use cables with a diameter slightly greater (up to 15%) than that of the passage opening.

Type	Dimensions	Compatible devices	Features	Part number
		 IB	Minimum band width: 100mm Connection: external cable Silicone resin filling: no	9BFF4
		 8G	Minimum band width: 100mm Connection: external cable and external bulb and capillary Silicone resin filling: no	9BFF10
		 8C	Minimum band width: 100mm Connection: external cable and external bulb and capillary Silicone resin filling: no	9BFF14

Indicative table of cable and wire diameters

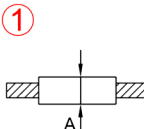
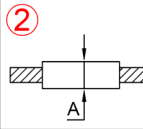
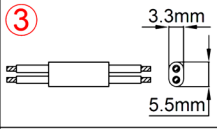
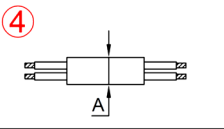
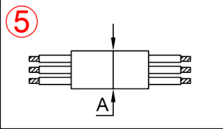
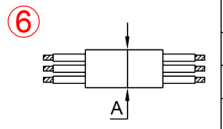
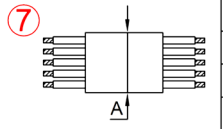
	<table border="1"> <tr><td>AWG22</td><td>A=Ø1.4±0.1</td></tr> <tr><td>AWG20</td><td>A=Ø1.6±0.1</td></tr> <tr><td>AWG18</td><td>A=Ø1.9±0.1</td></tr> <tr><td>AWG16</td><td>A=Ø2.2±0.1</td></tr> <tr><td>AWG15</td><td>A=Ø2.3±0.1</td></tr> </table>	AWG22	A=Ø1.4±0.1	AWG20	A=Ø1.6±0.1	AWG18	A=Ø1.9±0.1	AWG16	A=Ø2.2±0.1	AWG15	A=Ø2.3±0.1		<table border="1"> <tr><td>0.5 mm²</td><td>A=Ø1.5±0.1</td></tr> <tr><td>0.75 mm²</td><td>A=Ø1.8±0.1</td></tr> <tr><td>1 mm²</td><td>A=Ø1.9±0.1</td></tr> <tr><td>1.5 mm²</td><td>A=Ø2.2±0.1</td></tr> </table>	0.5 mm ²	A=Ø1.5±0.1	0.75 mm ²	A=Ø1.8±0.1	1 mm ²	A=Ø1.9±0.1	1.5 mm ²	A=Ø2.2±0.1		<table border="1"> <tr><td>3.3mm</td></tr> <tr><td>5.5mm</td></tr> <tr><td>2 X 0.75 mm²</td></tr> </table>	3.3mm	5.5mm	2 X 0.75 mm ²
AWG22	A=Ø1.4±0.1																									
AWG20	A=Ø1.6±0.1																									
AWG18	A=Ø1.9±0.1																									
AWG16	A=Ø2.2±0.1																									
AWG15	A=Ø2.3±0.1																									
0.5 mm ²	A=Ø1.5±0.1																									
0.75 mm ²	A=Ø1.8±0.1																									
1 mm ²	A=Ø1.9±0.1																									
1.5 mm ²	A=Ø2.2±0.1																									
3.3mm																										
5.5mm																										
2 X 0.75 mm ²																										
	<table border="1"> <tr><td>2 X 0.75 mm²</td><td>A=Ø6.5±0.1</td></tr> <tr><td>2 X 1 mm²</td><td>A=Ø6.8±0.1</td></tr> </table>	2 X 0.75 mm ²	A=Ø6.5±0.1	2 X 1 mm ²	A=Ø6.8±0.1		<table border="1"> <tr><td>3 X 1 mm²</td><td>A=Ø7.2±0.1</td></tr> <tr><td>3 X 1.5 mm²</td><td>A=Ø8.4±0.1</td></tr> </table>	3 X 1 mm ²	A=Ø7.2±0.1	3 X 1.5 mm ²	A=Ø8.4±0.1		<table border="1"> <tr><td>3 X 1.5 mm²</td><td>A=Ø9.1±0.2</td></tr> <tr><td>3 X 1 mm²</td><td>A=Ø7.4±0.2</td></tr> <tr><td>3 X AWG18</td><td>A=Ø7.8±0.2</td></tr> <tr><td>3 X AWG16</td><td>A=Ø8.4±0.2</td></tr> </table>	3 X 1.5 mm ²	A=Ø9.1±0.2	3 X 1 mm ²	A=Ø7.4±0.2	3 X AWG18	A=Ø7.8±0.2	3 X AWG16	A=Ø8.4±0.2					
2 X 0.75 mm ²	A=Ø6.5±0.1																									
2 X 1 mm ²	A=Ø6.8±0.1																									
3 X 1 mm ²	A=Ø7.2±0.1																									
3 X 1.5 mm ²	A=Ø8.4±0.1																									
3 X 1.5 mm ²	A=Ø9.1±0.2																									
3 X 1 mm ²	A=Ø7.4±0.2																									
3 X AWG18	A=Ø7.8±0.2																									
3 X AWG16	A=Ø8.4±0.2																									
	<table border="1"> <tr><td>5 X 1.5 mm²</td><td>A=Ø11.1±0.2</td></tr> <tr><td>5 X 1 mm²</td><td>A=Ø9.0±0.2</td></tr> <tr><td>5 X AWG18</td><td>A=Ø9.3±0.2</td></tr> <tr><td>5 X AWG16</td><td>A=Ø10.1±0.2</td></tr> </table>	5 X 1.5 mm ²	A=Ø11.1±0.2	5 X 1 mm ²	A=Ø9.0±0.2	5 X AWG18	A=Ø9.3±0.2	5 X AWG16	A=Ø10.1±0.2																	
5 X 1.5 mm ²	A=Ø11.1±0.2																									
5 X 1 mm ²	A=Ø9.0±0.2																									
5 X AWG18	A=Ø9.3±0.2																									
5 X AWG16	A=Ø10.1±0.2																									

1: Round wires FEP insulation, 300V, dimensions USA;
 2: Round wires FEP insulation, 300V, European dimensions;
 3: Flat cable PVC insulation, 300V, European dimensions;
 4: Round cables 2 conductors PVC insulation, 300V, European dimensions;
 5: Round cables 3 conductors PVC insulation, 300V, European dimensions;
 6: Round cables 3 conductors rubber insulation 300V, European and USA dimensions.
 7: Round cables 5 conductors rubber insulation 300V, European and USA dimensions.

Because of permanent improvement of our products, drawings, descriptions, features used on these data sheets are for guidance only and can be modified without prior advice



Contact us

Web: www.ultimheat.com



Cat25-2-9-5

Silicone boots for **cable outputs** on flexible silicone heaters surface. Assembly by bonding or vulcanization.

Type

9BFH

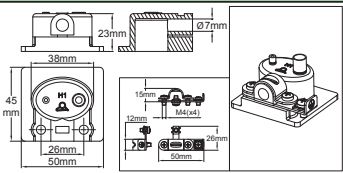
These enclosures include a stainless-steel removable locking device for the power cable and an internal and external grounding terminal. The flexibility of the silicone makes it possible to use cables with a diameter slightly greater (up to 15%) than that of the passage opening.

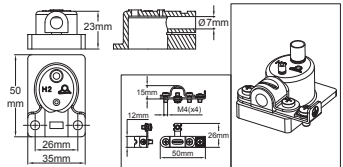
Type	Dimensions	Compatible devices	Features	Part number
		Band heaters with 50mm minimum width	Minimum band width: 50mm Connection: external cable Silicone resin filling: yes	9BFH1
		Band heaters with 35mm minimum width	Minimum band width: 35mm Connection: external cable Silicone resin filling: no	9BFH2

Indicative table of cable and wire diameters

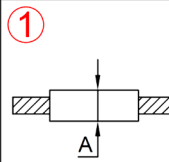
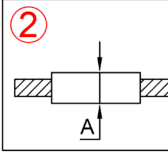
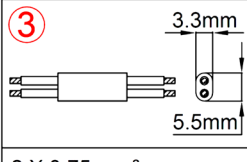
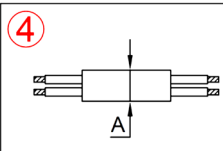
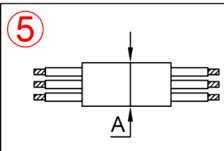
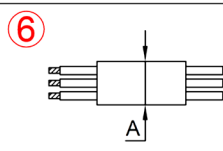
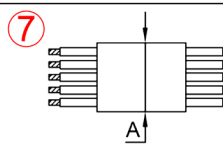
 <p>①</p>	AWG22	A=Ø1.4±0.1	 <p>②</p>	0.5 mm ²	A=Ø1.5±0.1	 <p>③</p>
	AWG20	A=Ø1.6±0.1		0.75 mm ²	A=Ø1.8±0.1	
	AWG18	A=Ø1.9±0.1		1 mm ²	A=Ø1.9±0.1	
	AWG16	A=Ø2.2±0.1		1.5 mm ²	A=Ø2.2±0.1	
	AWG15	A=Ø2.3±0.1		2 X 0.75 mm ²		
 <p>④</p>	2 X 0.75 mm ²	A=Ø6.5±0.1	 <p>⑤</p>	3 X 1.5 mm ²	A=Ø8.4±0.2	
	2 X 1 mm ²	A=Ø6.8±0.1		3 X 1 mm ²	A=Ø7.2±0.1	
 <p>⑥</p>	3 X 1.5 mm ²	A=Ø9.1±0.2	 <p>⑦</p>	3 X 1 mm ²	A=Ø7.4±0.2	
	3 X AWG18	A=Ø7.8±0.2		3 X AWG16	A=Ø8.4±0.2	
	5 X 1.5 mm ²	A=Ø11.1±0.2		5 X 1 mm ²	A=Ø9.0±0.2	
	5 X AWG18	A=Ø9.3±0.2		5 X AWG16	A=Ø10.1±0.2	

1: Round wires FEP insulation, 300V, dimensions USA;
 2: Round wires FEP insulation, 300V, European dimensions;
 3: Flat cable PVC insulation, 300V, European dimensions;
 4: Round cables 2 conductors PVC insulation, 300V, European dimensions;
 5: Round cables 3 conductors PVC insulation, 300V, European dimensions;
 6: Round cables 3 conductors rubber insulation 300V, European and USA dimensions.
 7: Round cables 5 conductors rubber insulation 300V, European and USA dimensions.

Because of permanent improvement of our products, drawings, descriptions, features used on these data sheets are for guidance only and can be modified without prior advice







Silicone boots for cable outputs with temperature limiters on flexible silicone heaters surface. Assembly by bonding or vulcanization.

Type

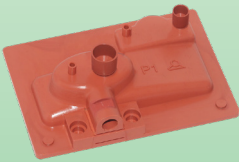
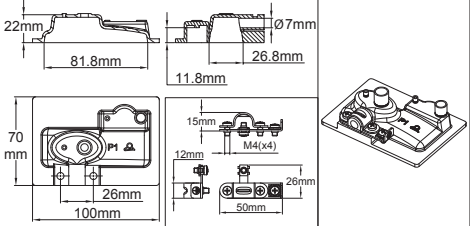
9BFP

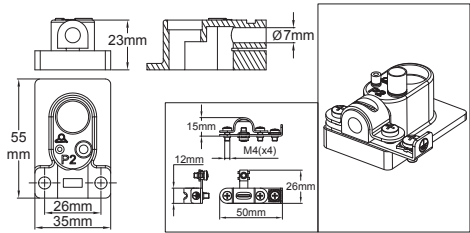
These enclosures include a stainless-steel removable locking device for the power cable and an internal and external grounding terminal. The flexibility of the silicone makes it possible to use cables with a diameter slightly greater (up to 15%) than that of the passage opening. They also comprise a degassing orifice and a «funnel» orifice for filling the silicone resin, which are cut after curing.

Type	Dimensions	Compatible devices	Features	Part number
		 4903	Minimum band width: 100mm Connection: external cable Silicone resin filling: yes	9BFP1
		 4903	Minimum band width: 35mm Connection: external cable Silicone resin filling: yes	9BFP2

Indicative table of cable and wire diameters

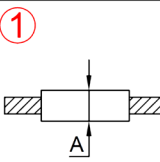
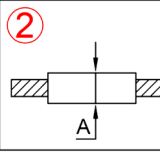
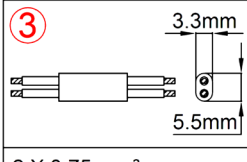
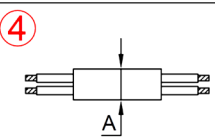
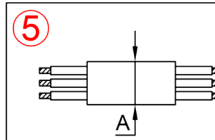
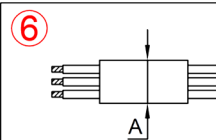
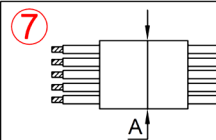
 <p>①</p>	AWG22	A=Ø1.4±0.1	 <p>②</p>	0.5 mm ²	A=Ø1.5±0.1	 <p>③</p>
	AWG20	A=Ø1.6±0.1		0.75 mm ²	A=Ø1.8±0.1	
	AWG18	A=Ø1.9±0.1		1 mm ²	A=Ø1.9±0.1	
	AWG16	A=Ø2.2±0.1		1.5 mm ²	A=Ø2.2±0.1	
	AWG15	A=Ø2.3±0.1		2 X 0.75 mm ²		
 <p>④</p>	2 X 0.75 mm ²	A=Ø6.5±0.1	 <p>⑤</p>	3 X 1.5 mm ²	A=Ø9.1±0.2	
	2 X 1 mm ²	A=Ø6.8±0.1		3 X 1 mm ²	A=Ø7.2±0.1	
 <p>⑥</p>	3 X 1 mm ²	A=Ø7.2±0.1	 <p>⑦</p>	3 X 1.5 mm ²	A=Ø9.1±0.2	
	3 X AWG18	A=Ø7.8±0.2		3 X 1 mm ²	A=Ø7.4±0.2	
	3 X AWG16	A=Ø8.4±0.2		3 X AWG18	A=Ø7.8±0.2	
				3 X AWG16	A=Ø8.4±0.2	
				5 X 1.5 mm ²	A=Ø11.1±0.2	
				5 X 1 mm ²	A=Ø9.0±0.2	
				5 X AWG18	A=Ø9.3±0.2	
				5 X AWG16	A=Ø10.1±0.2	

- 1: Round wires FEP insulation, 300V, dimensions USA;
- 2: Round wires FEP insulation, 300V, European dimensions;
- 3: Flat cable PVC insulation, 300V, European dimensions;
- 4: Round cables 2 conductors PVC insulation, 300V, European dimensions;
- 5: Round cables 3 conductors PVC insulation, 300V, European dimensions;
- 6: Round cables 3 conductors rubber insulation 300V, European and USA dimensions.
- 7: Round cables 5 conductors rubber insulation 300V, European and USA dimensions.

Because of permanent improvement of our products, drawings, descriptions, features used on these data sheets are for guidance only and can be modified without prior advice



Contact us

Web: www.ultimheat.com





Cat25-2-9-7

Silicone boots for **cable outputs and temperature sensor** on flexible silicone heaters surface. Assembly by bonding or vulcanization.

Type

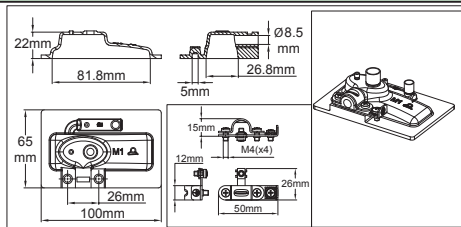
9BFM

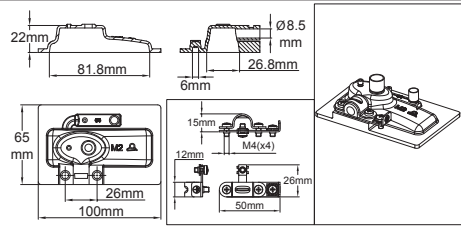
These enclosures include a stainless-steel removable locking device for the power cable and an internal and external grounding terminal. The flexibility of the silicone makes it possible to use cables with a diameter slightly greater (up to 15%) than that of the passage opening. They also comprise a degassing orifice and a «funnel» orifice for filling the silicone resin, which are cut after curing.

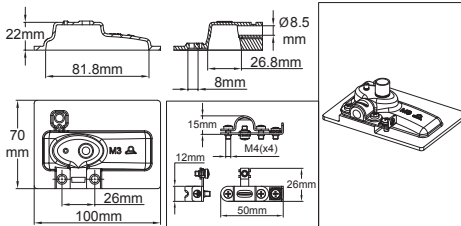
Type	Dimensions	Compatible devices	Features	Part number
		Dia 5mm temperature sensors with 30mm maximum probe length	Minimum band width: 100mm Connection: 5 conductor external cable Silicone resin filling: yes	9BFM1
		Dia. 6mm temperature sensors with 30mm maximum probe length	Minimum band width: 100mm Connection: 5 conductor external cable Silicone resin filling: yes	9BFM2
		Naked welding thermocouples, glass bead NTC, flat chip Pt100	Minimum band width: 100mm Connection: 5 conductor external cable Silicone resin filling: yes	9BFM3

Indicative table of cable and wire diameters

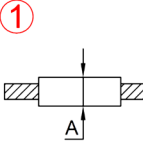
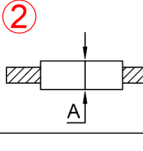
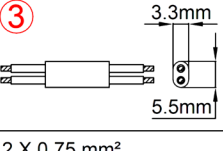
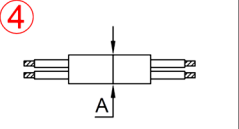
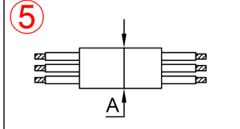
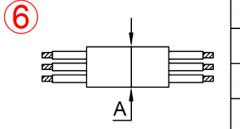
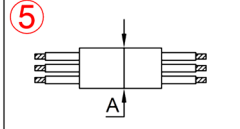
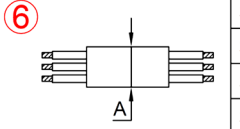
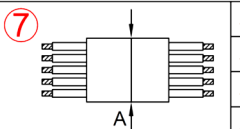
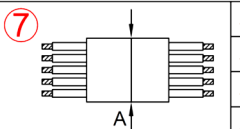
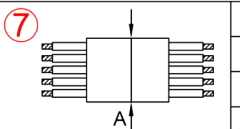
	AWG22	A=Ø1.4±0.1		0.5 mm ²	A=Ø1.5±0.1	
	AWG20	A=Ø1.6±0.1		0.75 mm ²	A=Ø1.8±0.1	
	AWG18	A=Ø1.9±0.1		1 mm ²	A=Ø1.9±0.1	
	AWG16	A=Ø2.2±0.1		1.5 mm ²	A=Ø2.2±0.1	
	AWG15	A=Ø2.3±0.1		2 X 0.75 mm ²		
	2 X 0.75 mm ²	A=Ø6.5±0.1			3 X 1.5 mm ²	A=Ø9.1±0.2
	2 X 1 mm ²	A=Ø6.8±0.1			3 X 1 mm ²	A=Ø7.2±0.1
	3 X 1 mm ²	A=Ø7.2±0.1			3 X AWG18	A=Ø7.8±0.2
	3 X 1.5 mm ²	A=Ø8.4±0.1			3 X AWG16	A=Ø8.4±0.2
	5 X 1.5 mm ²	A=Ø11.1±0.2		5 X 1.5 mm ²	A=Ø11.1±0.2	
	5 X 1 mm ²	A=Ø9.0±0.2		5 X 1 mm ²	A=Ø9.0±0.2	
	5 X AWG18	A=Ø9.3±0.2		5 X AWG18	A=Ø9.3±0.2	
	5 X AWG16	A=Ø10.1±0.2		5 X AWG16	A=Ø10.1±0.2	

1: Round wires FEP insulation, 300V, dimensions USA;
2: Round wires FEP insulation, 300V, European dimensions;
3: Flat cable PVC insulation, 300V, European dimensions;
4: Round cables 2 conductors PVC insulation, 300V, European dimensions;
5: Round cables 3 conductors PVC insulation, 300V, European dimensions;
6: Round cables 3 conductors rubber insulation 300V, European and USA dimensions.
7: Round cables 5 conductors rubber insulation 300V, European and USA dimensions.

Because of permanent improvement of our products, drawings, descriptions, features used on these data sheets are for guidance only and can be modified without prior advice





Various accessories for flexible silicone heaters





Base heater for 55 gallons metal drum

Heating surface	Power	Enclosure	Ingress protection	Temperature control	Type
Dia. 560mm	1000W	304 Stainless steel	IP69K	10-150°C thermostat	9V4

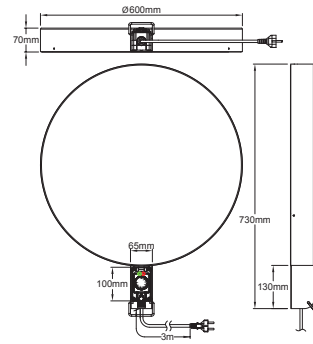

Main Features

These heaters are used to heat the 200-220 liters (55 US gallons, 45 Imperial Gallons) drums and their lower size versions. Completely made of 304 stainless steel, 1.2 and 2mm thick, resistant to high pressure hot water jet washing, **they can withstand industrial environment, food and chemical applications**. They are not usable in explosive areas. The drum simply needs to be put on these pedestals. The surface load of the heating element is limited to a safe value of 0.5W/cm² and the surface temperature is limited to 150°C. They can be used alone in reheating, with or without insulating jacket, or in addition to jacket heaters or heating belts, and in the latter case, they greatly reduce the heating time. As for all heaters for containers and tanks, it is mandatory to keep a connection to atmospheric pressure to avoid an internal overpressure which could burst the barrel. They come standard with 3 x1mm² rubber insulated cable, for industrial applications.

Heating surface: 3.5mm thick silicone flat element vulcanized under the upper surface and covering the entire 600mm diameter surface. This technique provides a uniform temperature.

Base: 304 stainless steel, 600mm diameter, height 70mm, TIG welded.

Control box: 56 mm x 63 mm, height 100 mm in PA66 reinforced fiberglass, with waterproof and sealable window. This control box is protected from violent shocks by a stainless-steel envelope. It has a handle for easy handling.

Ingress protection class: IP69K

Temperature control: By bulb and capillary thermostat with 10-150°C adjustment range. Other temperature ranges 4-40°C, (39-104°F) 30-90°C (86-,194°F) 30-110°C (86-230°F) are available in option. Access to the thermostat setting is possible opening the window.

Cable gland: M20 in PA66.

Connection cable: Rubber insulated, for industrial environments, 3 x 1mm², length 3m, with Euro plug or UL plug.

Surface load: 0.5 W/cm²

Supply voltage: 230V (110V on request)

Standard equipment: Green and red pilot lights, indicating power on and operation of the heater

Accessories: Insulating Jackets

Standards: Built in accordance with applicable European standards (CE marking)



Instructions for use: Observe the instruction manual enclosed with the device.

Main part numbers (°C printed knob) *

With 10-150°C (50-300°F), thermostat with 3 meters cord with Euro plug	With 10-150°C (50-300°F), thermostat with 3 meters cord with UL plug
9V46004A0088C3E	9V46004A0088C3U

* °F printed knob: replace C by F in the part number.



Type	Features	Part number
	<p>Room Temperature Vulcanizing Silicone. Very fluid, fills the boots well and without bubbles. Also allows to bond flexible silicone heaters on metal walls. Comes with a special nozzle that directs the liquid silicone in the desired location without spilling. To be used on clean and degreased surfaces with isopropyl alcohol or methanol</p> <p>Color: Iron oxide red</p> <p>Packaging: 45 ml tube.</p> <p>Temperature resistance when fully vulcanized: 280°C.</p> <p>Vulcanization time at room temperature: 24 to 48 hours depending on thickness. Don't energize when the silicone is not completely vulcanized.</p> <p>Vulcanized hardness: 35 Shore A</p> <p>Volume resistivity: 4*10¹⁵ ohms/cm.</p> <p>Elongation: 150%.</p> <p>Breakdown voltage: 16KV/mm.</p> <p>Life in closed tube: 3 months. Keep in cold and dry place.</p>	<p>6YTMC2</p>
	<p>Grounding cable, 1.5m long, 1.5mm², FEP insulation, equipped with a 4mm diameter grommet for connection to the ground terminals of the silicone flexible elements, and an alligator clip at the other end, for connection to heated metal parts.</p>	<p>9A66GT1</p>

Because of permanent improvement of our products, drawings, descriptions, features used on these data sheets are for guidance only and can be modified without prior advice



En raison de l'évolution technique constante de nos produits, les plans, dessins, photos et caractéristiques repris dans les pages techniques sont communiqués sans engagement et peuvent être modifiés sans préavis



[Contact us](#)

Web: www.ultimheat.com

Other catalogues

 **ULTIMHEAT**[®] **21**
(2nd edition)





Industrial jacket heaters

for metal, plastic and glass containers

The Gigathermic[®] professional range

The professional solution: an extended, rational, and consistent range of products
Technical catalogue for R&D department
Edition 09/07/2019

 [Contact us](#) [Web: www.ultimheat.com](http://www.ultimheat.com)

 **ULTIMHEAT**[®] **22**
(3rd edition)



Immersion heaters

The Gigathermic[®] professional range

The professional solution: an extended, rational, and consistent range of products
Technical catalogue for R&D department
Edition 06/07/2019

 [Contact us](#) [Web: www.ultimheat.com](http://www.ultimheat.com)

 **ULTIMHEAT**[®] **23**
(2nd edition)





Flow throw liquid heaters for incorporation

The Gigathermic[®] professional range

The professional solution: an extended, rational, and consistent range of products
Technical catalogue for R&D department
Edition 11/09/2019

 [Contact us](#) [Web: www.ultimheat.com](http://www.ultimheat.com)

 **ULTIMHEAT**[®] **24**
(2nd edition)



Air heating solutions

The Gigathermic[®] professional range

The professional solution: an extended, rational, and consistent range of products
Technical catalogue for R&D department
Edition 12/09/2019

 [Contact us](#) [Web: www.ultimheat.com](http://www.ultimheat.com)



[Contact us](#)

[Web: www.ultimheat.com](http://www.ultimheat.com)