

Rev.no.	Revision	Date	By :	Drawer:
---------	----------	------	------	---------

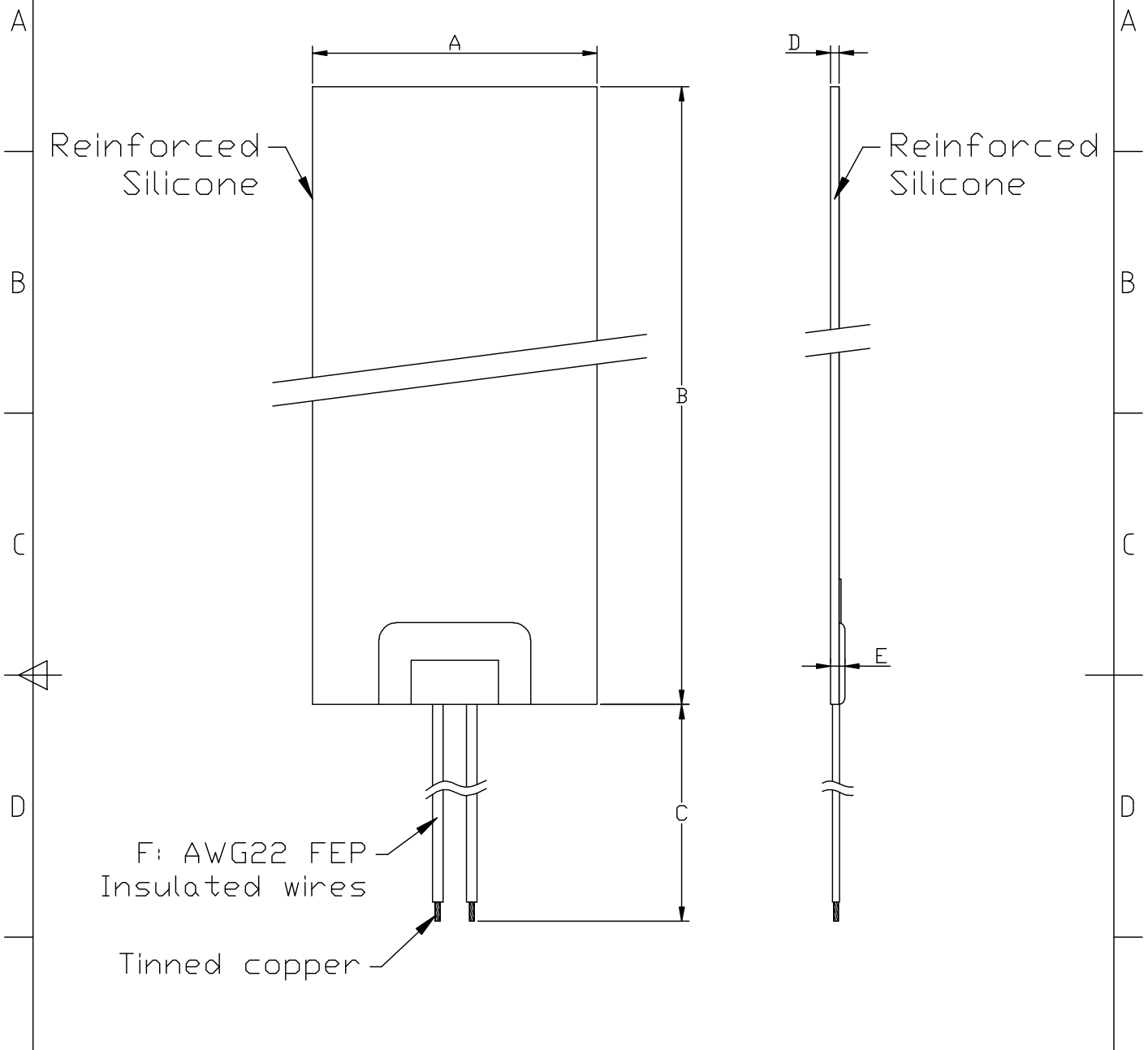

Power	Voltage	Material	W/cm <sup>2</sup>
320W	110/115V	Silicone	0.8

QC CONTROL

	Value	Criticality	% Checked		Value	Criticality	% Checked		Value	Criticality	% Checked
A	100	-	-	D	1.6	-	-	G	-----	-	-
B	400	-	-	E	2.5	-	-	H	-----	-	-
C	200	-	-	F	AWG22 FEP	-	-	I	-----	-	-

Do not scale drawing  
This print is the exclusive property of Blue Ink and cannot be reproduced in whole or in part or issued or disclosed to third parties without the expressed written consent of Blue Ink

Tool number: \_\_\_\_\_ Made with : \_\_\_\_\_

Drawn by : / Date : HJH 01/07/2011  
Checked by : / Date : J.J 01/07/2011  
Raw materials: UL V0 Silicone  
Scale:1/1

Blue Ink, Bangkok, Thailand

IF NOT SPECIFIED : (1)Dimensions are in mm;(2)General tolerance are ISO 2768-1.

Part Number \_\_\_\_\_

Page No. 1/1