

Rev.no.	Revision	Date	By :	Drawer:
---------	----------	------	------	---------

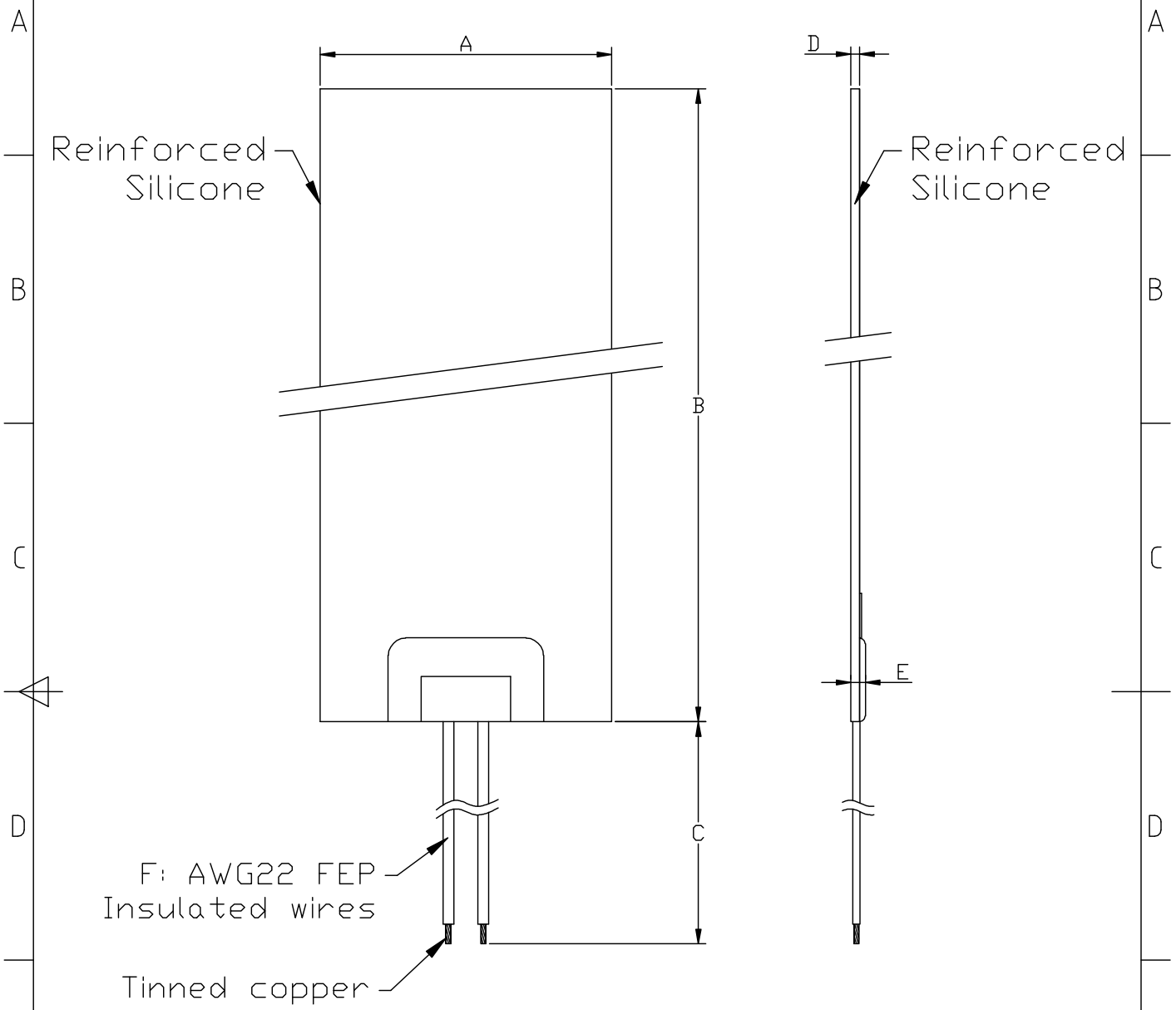

Power	Voltage	Material	W/cm ²
40W	220/230V	Silicone	0.4

QC CONTROL

	Value	Criticality	% Checked		Value	Criticality	% Checked		Value	Criticality	% Checked
A	100	-	-	D	1.6	-	-	G	-----	-	-
B	100	-	-	E	2.5	-	-	H	-----	-	-
C	200	-	-	F	AWG22 FEP	-	-	I	-----	-	-

Do not scale drawing
This print is the exclusive property of Blue Ink and cannot be reproduced in whole or in part or issued or disclosed to third parties without the expressed written consent of Blue Ink

Tool number: _____ Made with : _____

Drawn by : / Date : HJH 01/07/2011
Checked by : / Date : J.J 01/07/2011
Raw materials: UL V0 Silicone
Scale:1/1

Blue Ink, Bangkok, Thailand

IF NOT SPECIFIED : (1)Dimensions are in mm;(2)General tolerance are ISO 2768-1.

Part Number _____

Page No. 1/1